

IGBT MODULE

# MBN1200D33C

Silicon N-channel IGBT

## FEATURES

- \* High speed, low loss IGBT module.
- \* Low driving power due to low input capacitance MOS gate.
- \* Low noise due to ultra soft fast recovery diode.
- \* High reliability, high durability module.
- \* High thermal fatigue durability.  
( $\Delta T_c=70^\circ\text{C}$ ,  $N>20,000$ cycles)
- \* Isolated head sink (terminal to base).

## CIRCUIT DIAGRAM

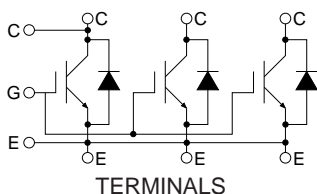

## OUTLINE DRAWING

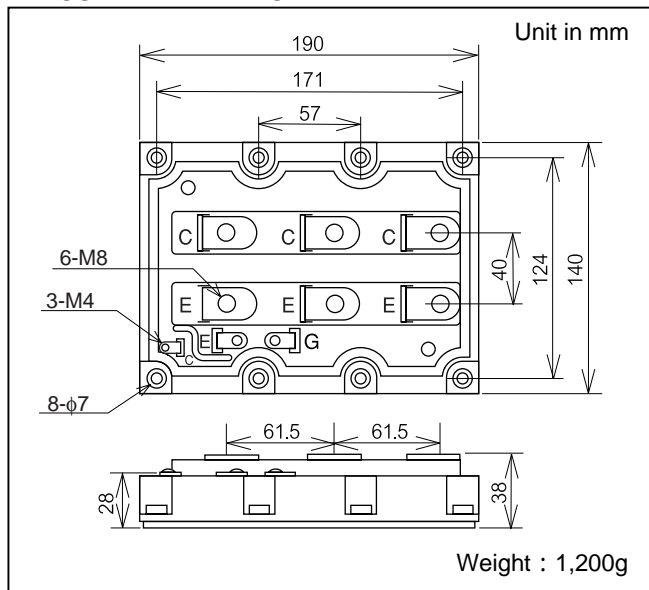

## ABSOLUTE MAXIMUM RATINGS ( $T_c=25^\circ\text{C}$ )

Item	Symbol	Unit	MBN1200D33C
Collector Emitter Voltage	$V_{CES}$	V	3,300
Gate Emitter Voltage	$V_{GES}$	V	$\pm 20$
Collector Current	DC	$I_C$	1,200
	1ms	$I_{Cp}$	2,400
Forward Current	DC	$I_F$	1,200
	1ms	$I_{FM}$	2,400
Junction Temperature	$T_j$	$^\circ\text{C}$	-40 ~ +125
Storage Temperature	$T_{stg}$	$^\circ\text{C}$	-40 ~ +125
Isolation Voltage	$V_{ISO}$	$V_{RMS}$	6,000(AC 1 minute)
Screw Torque	Terminals (M4/M8)	-	2/10 (1)
	Mounting (M6)	-	6 (2)

Notes: (1) Recommended Value  $1.8 \pm 0.2/9 \pm 1 \text{ N}\cdot\text{m}$  (2) Recommended Value  $5.5 \pm 0.5 \text{ N}\cdot\text{m}$

## ELECTRICAL CHARACTERISTICS

Item	Symbol	Unit	Min.	Typ.	Max.	Test Conditions	
Collector Emitter Cut-Off Current	$I_{CES}$	mA	-	-	12	$V_{CE}=3,300\text{V}$ , $V_{GE}=0\text{V}$ , $T_j=25^\circ\text{C}$	
			-	30	60	$V_{CE}=3,300\text{V}$ , $V_{GE}=0\text{V}$ , $T_j=125^\circ\text{C}$	
Gate Emitter Leakage Current	$I_{GES}$	nA	-500	-	+500	$V_{GE}=\pm 20\text{V}$ , $V_{CE}=0\text{V}$ , $T_j=25^\circ\text{C}$	
Collector Emitter Saturation Voltage	$V_{CE(sat)}$	V	-	4.8	5.4	$I_C=1,200\text{A}$ , $V_{GE}=15\text{V}$ , $T_j=125^\circ\text{C}$	
Gate Emitter Threshold Voltage	$V_{GE(TH)}$	V	4.0	5.5	6.5	$V_{CE}=10\text{V}$ , $I_C=1,200\text{mA}$ , $T_j=25^\circ\text{C}$	
Input Capacitance	$C_{ies}$	nF	-	140	-	$V_{CE}=10\text{V}$ , $V_{GE}=0\text{V}$ , $f=100\text{kHz}$ , $T_j=25^\circ\text{C}$	
			Rise Time	$t_r$	-	2.0	3.2
Switching Times	Turn On Time	$t_{on}$	-	2.9	3.8	$L=100\text{nH}$	
	Fall Time	$t_f$	-	1.7	3.2	$R_G=3.3\Omega$ (3)	
	Turn Off Time	$t_{off}$	-	3.5	5.6	$V_{GE}=\pm 15\text{V}$ , $T_j=125^\circ\text{C}$	
			Peak Forward Voltage Drop	$V_{FM}$	V	-	2.5
Reverse Recovery Time	$t_{rr}$	$\mu\text{s}$	-	0.8	1.4	$V_{CC}=1,650\text{V}$ , $I_C=1,200\text{A}$ , $L=100\text{nH}$ $T_j=125^\circ\text{C}$	
Turn On Loss	$E_{on(10\%)}$	J/P	-	2.1	2.75	$V_{CC}=1,650\text{V}$ , $I_C=1,200\text{A}$ , $L=100\text{nH}$	
Turn Off Loss	$E_{off(10\%)}$	J/P	-	1.6	2.1	$R_G=3.3\Omega$ (3)	
Reverse Recovery Loss	$E_{rr(10\%)}$	J/P	-	1.5	2.1	$V_{GE}=\pm 15\text{V}$ , $T_j=125^\circ\text{C}$	
Thermal Impedance	IGBT	$R_{th(j-c)}$	$^\circ\text{C/W}$	-	-	0.008	Junction to case
	FWD	$R_{th(j-c)}$		-	-	0.016	

Notes:(3)  $R_G$  value is the test condition's value for evaluation of the switching times, not recommended value.

Please, determine the suitable  $R_G$  value after the measurement of switching waveforms (overshoot voltage, etc.) with appliance mounted.

- \* Please contact our representatives at order.
- \* For improvement, specifications are subject to change without notice.
- \* For actual application, please confirm this spec sheet is the newest revision.

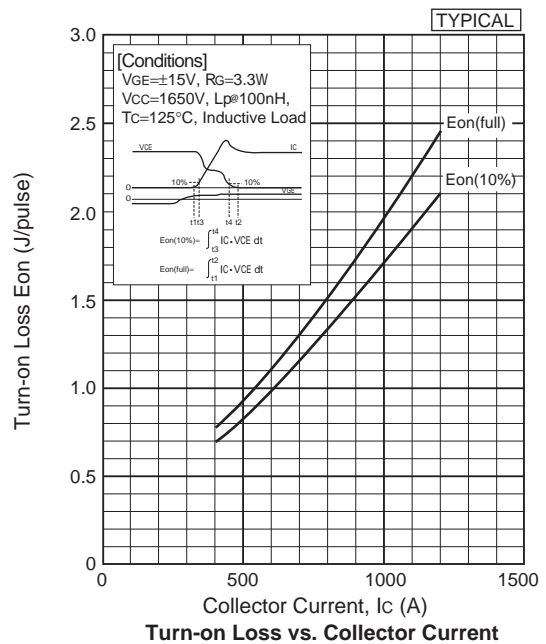
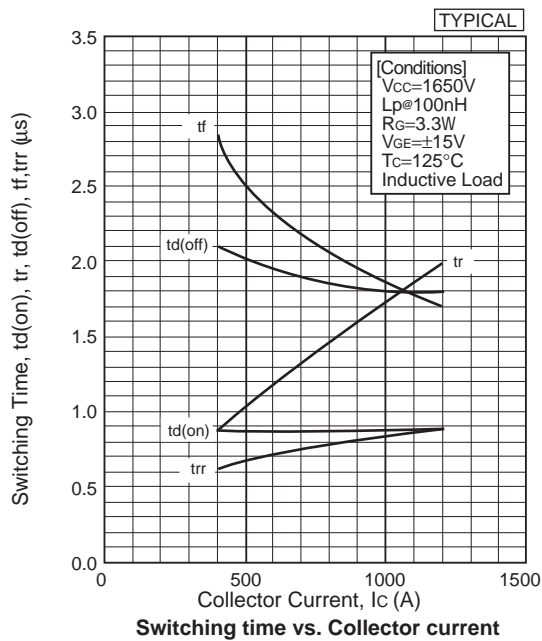
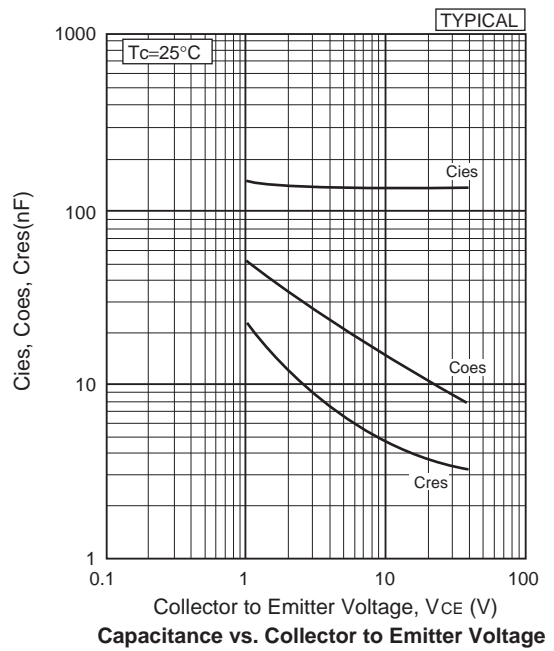
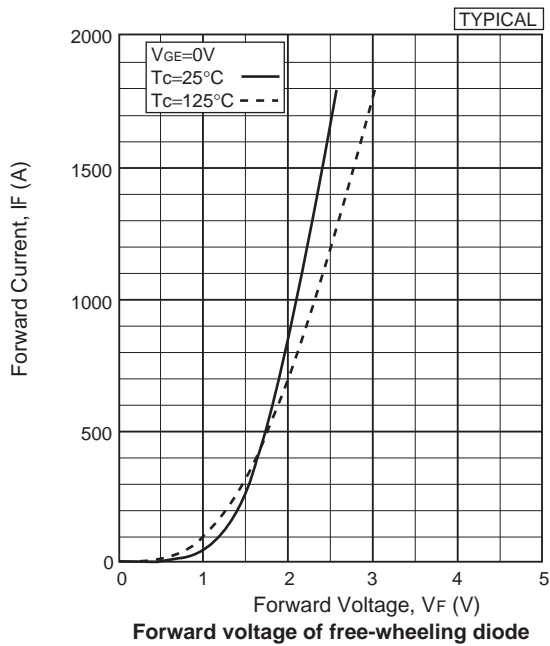
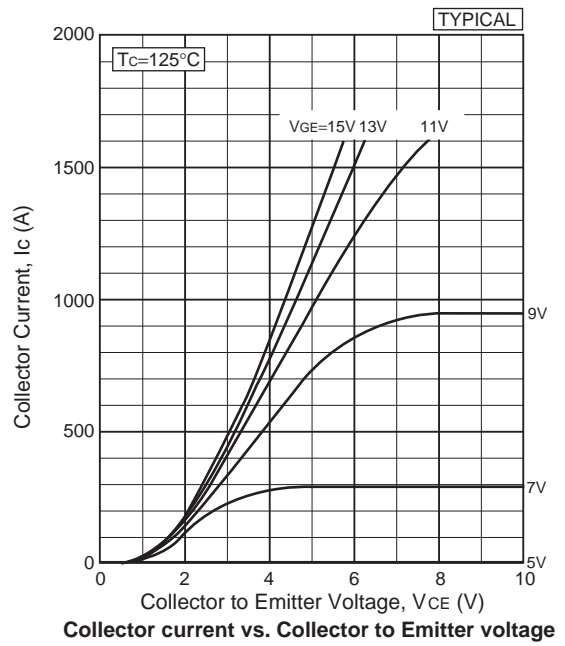
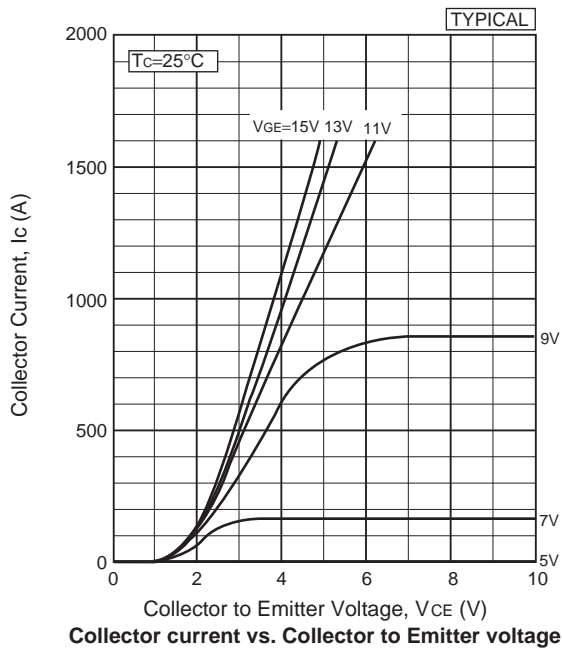

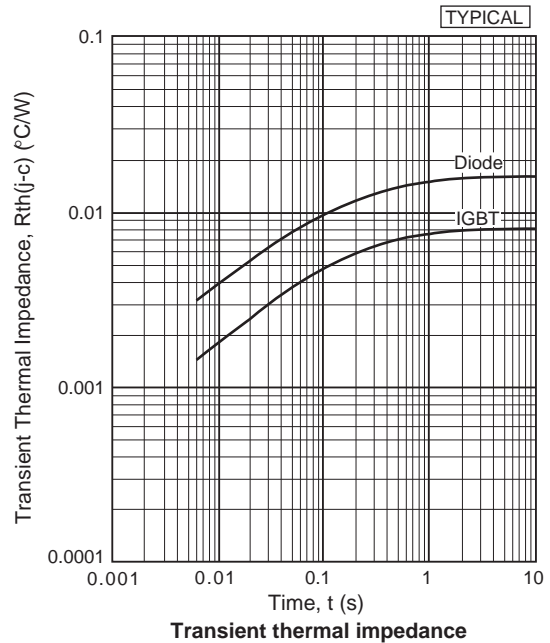
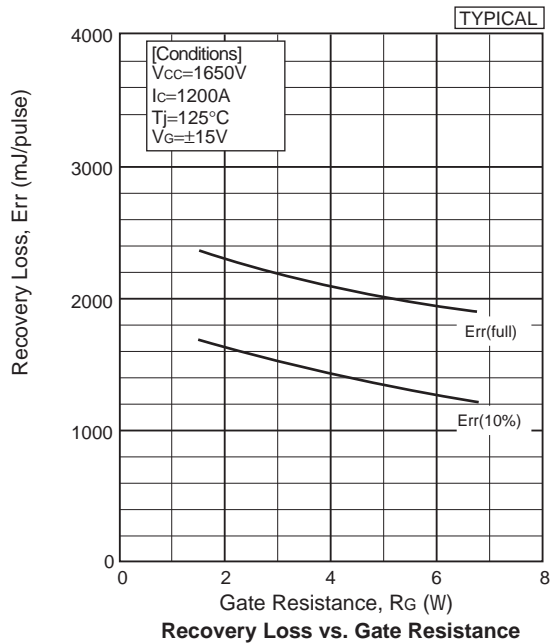
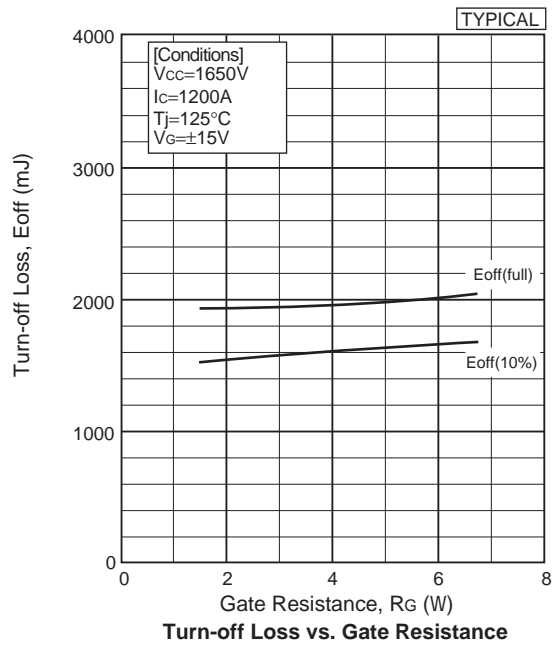
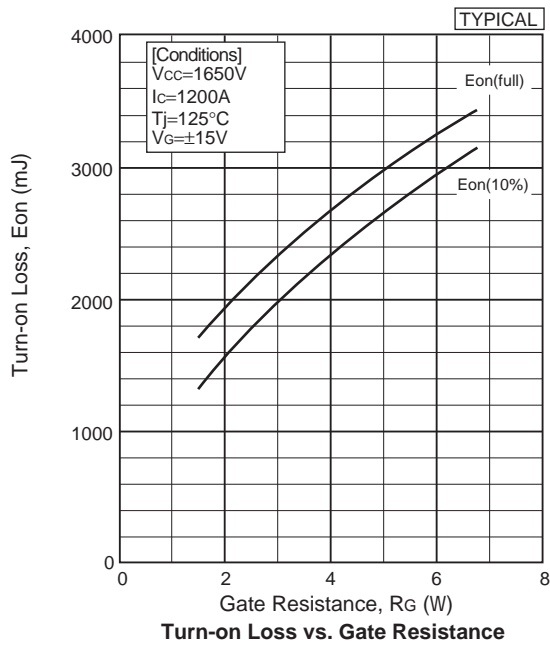
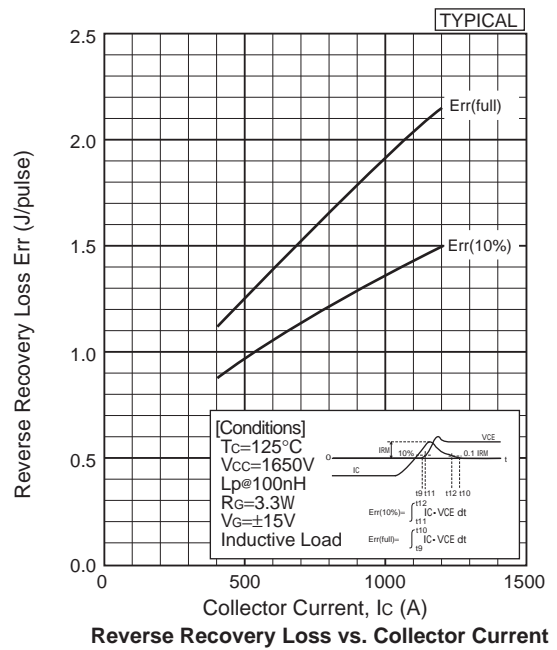
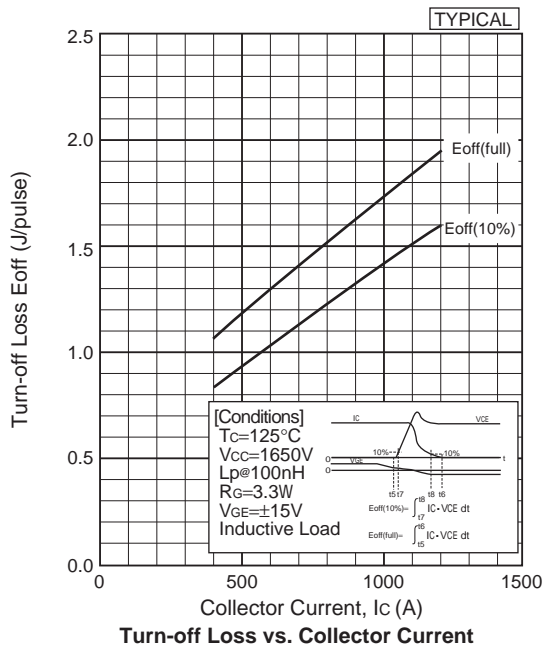

# HITACHI POWER SEMICONDUCTORS

## Notices

1. The information given herein, including the specifications and dimensions, is subject to change without prior notice to improve product characteristics. Before ordering, purchasers are advised to contact Hitachi sales department for the latest version of this data sheets.
2. Please be sure to read "Precautions for Safe Use and Notices" in the individual brochure before use.
3. In cases where extremely high reliability is required (such as use in nuclear power control, aerospace and aviation, traffic equipment, life-support-related medical equipment, fuel control equipment and various kinds of safety equipment), safety should be ensured by using semiconductor devices that feature assured safety or by means of users' fail-safe precautions or other arrangement. Or consult Hitachi's sales department staff.
4. In no event shall Hitachi be liable for any damages that may result from an accident or any other cause during operation of the user's units according to this data sheets. Hitachi assumes no responsibility for any intellectual property claims or any other problems that may result from applications of information, products or circuits described in this data sheets.
5. In no event shall Hitachi be liable for any failure in a semiconductor device or any secondary damage resulting from use at a value exceeding the absolute maximum rating.
6. No license is granted by this data sheets under any patents or other rights of any third party or Hitachi, Ltd.
7. This data sheets may not be reproduced or duplicated, in any form, in whole or in part , without the expressed written permission of Hitachi, Ltd.
8. The products (technologies) described in this data sheets are not to be provided to any party whose purpose in their application will hinder maintenance of international peace and safety not are they to be applied to that purpose by their direct purchasers or any third party. When exporting these products (technologies), the necessary procedures are to be taken in accordance with related laws and regulations.

■ For inquiries relating to the products, please contact nearest overseas representatives which is located "Inquiry" portion on the top page of a home page.

Hitachi power semiconductor home page address <http://www.hitachi.co.jp/pse>