

MITSUBISHI DIODE MODULES

**RM100D2Z-40**HIGH VOLTAGE MEDIUM POWER GENERAL USE  
INSULATED TYPE

RM100D2Z-40



- **IF(AV)** Average forward current ..... **100A**
- **VRRM** Repetitive peak reverse voltage  
..... **2000V**

- **DOUBLE ARMS**
- **Insulated Type**
- **UL Recognized**

Yellow Card No. E80276 (N)

File No. E80271

**APPLICATION**

AC motor controllers, DC motor controllers, Battery DC power supplies,  
DC power supplies for control panels, and other general DC power equipment

**OUTLINE DRAWING & CIRCUIT DIAGRAM**

Dimensions in mm

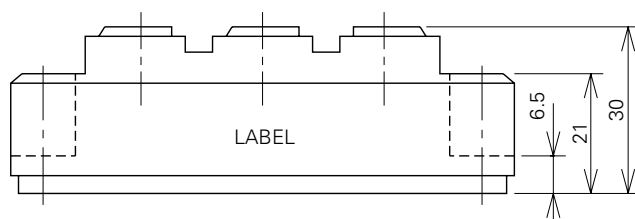
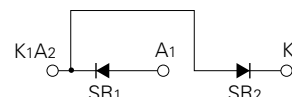
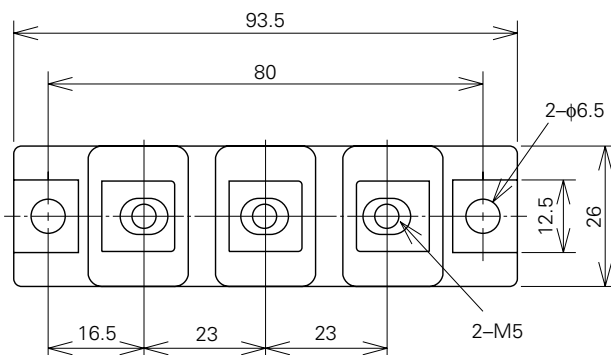

Feb.1999



## MITSUBISHI DIODE MODULES

## RM100D2Z-40

## HIGH VOLTAGE MEDIUM POWER GENERAL USE

## INSULATED TYPE

## ABSOLUTE MAXIMUM RATINGS

Symbol	Parameter	Voltage class		Unit
		40		
VRRM	Repetitive peak reverse voltage	2000		V
VRSM	Non-repetitive peak reverse voltage	2100		V
VR (DC)	Reverse DC voltage	1600		V

Symbol	Parameter	Conditions	Ratings	Unit
IF (RMS)	RMS forward current		155	A
IF (AV)	Average forward current	Single-phase, half-wave 180° conduction, Tc=87°C	100	A
IFSM	Surge (non-repetitive) forward current	One half cycle at 60Hz, peak value	2000	A
I <sup>2</sup> t	I <sup>2</sup> t for fusing	Value for one cycle of surge current	1.7 × 10 <sup>4</sup>	A <sup>2</sup> s
f	Maximum operating frequency		1000	Hz
T <sub>j</sub>	Junction temperature		-40~+125	°C
T <sub>stg</sub>	Storage temperature		-40~+125	°C
V <sub>iso</sub>	Isolation voltage	Charged part to case	3000	V
—	Mounting torque	Main terminal screw M5	1.47~1.96	N·m
			15~20	kg·cm
		Mounting screw M6	1.96~2.94	N·m
—	Weight	Typical value	20~30	kg·cm
—	Weight	Typical value	160	g

## ELECTRICAL CHARACTERISTICS

Symbol	Parameter	Test conditions	Limits			Unit
			Min.	Typ.	Max.	
I <sub>RRM</sub>	Repetitive reverse current	T <sub>j</sub> =125°C, V <sub>RRM</sub> applied	—	—	15	mA
V <sub>FM</sub>	Forward voltage	T <sub>j</sub> =25°C, I <sub>FM</sub> =320A, instantaneous meas.	—	—	1.35	V
R <sub>th (j-c)</sub>	Thermal resistance	Junction to case (per 1/2 module)	—	—	0.3	°C/W
R <sub>th (c-f)</sub>	Contact thermal resistance	Case to fin, conductive grease applied (per 1/2 module)	—	—	0.2	°C/W
—	Insulation resistance	Measured with a 500V megohmmeter between main terminal and case	10	—	—	MΩ

Feb.1999



MITSUBISHI DIODE MODULES

**RM100D2Z-40**

**HIGH VOLTAGE MEDIUM POWER GENERAL USE  
INSULATED TYPE**

**PERFORMANCE CURVES**

**MAXIMUM FORWARD CHARACTERISTIC**

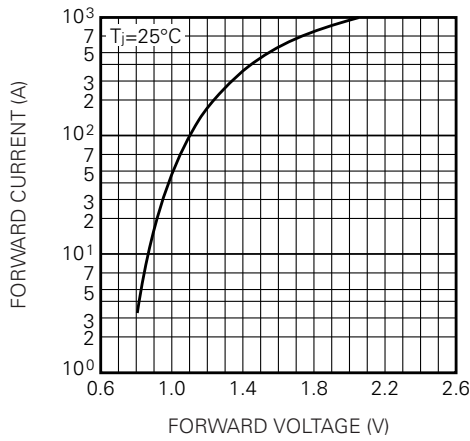

**ALLOWABLE SURGE (NON-REPETITIVE) FORWARD CURRENT**

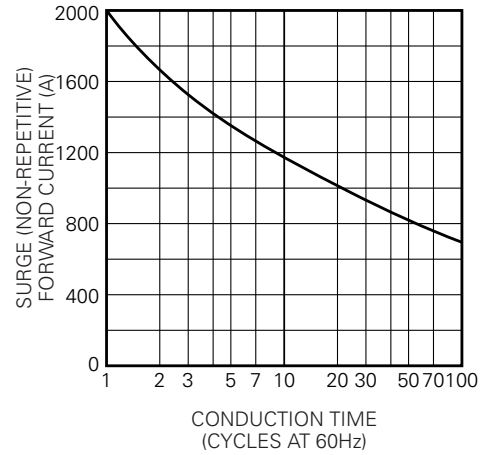

**MAXIMUM TRANSIENT THERMAL IMPEDANCE (JUNCTION TO CASE)**

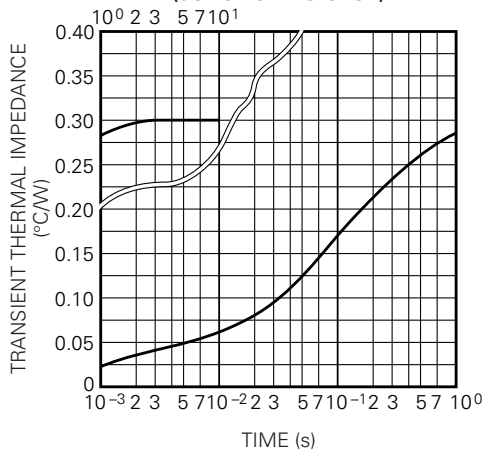

**MAXIMUM POWER DISSIPATION**

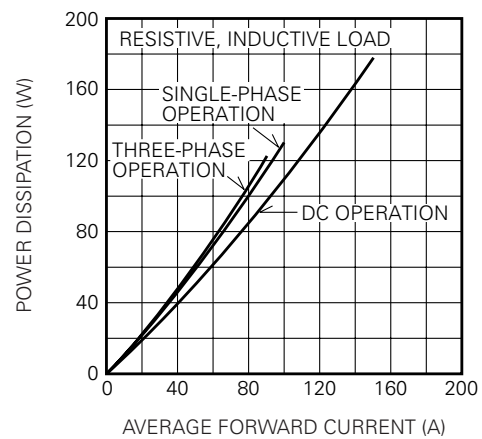

**ALLOWABLE CASE TEMPERATURE VS. AVERAGE FORWARD CURRENT**

