



60W Single Output LED Power Supply

PLC-60 series



■ Features :

- Universal AC input / Full range
- High efficiency 89%
- Adjustable output voltage and current level
- Protections: Short circuit/Over load/Over voltage/Over temperature
- Cooling by free air convection
- Built-in constant current limiting circuit
- Fully isolated plastic case with terminal block style of I/O
- Built-in active PFC function, comply with EN61000-3-2 class C ($\geq 75\%$ load)
- Class II power unit, no FG
- Pass LPS
- 100% full load burn-in test
- High reliability
- Suitable for LED lighting and moving sign applications (Note.2)
- Compliance to worldwide safety regulations for lighting
- 2 years warranty

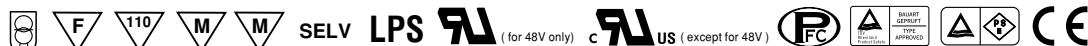

SPECIFICATION

MODEL	PLC-60-12	PLC-60-15	PLC-60-20	PLC-60-24	PLC-60-27	PLC-60-36	PLC-60-48	
OUTPUT	DC VOLTAGE	12V	15V	20V	24V	27V	36V	48V
	CONSTANT CURRENT REGION Note.6	8.4 ~ 12V	10.5 ~ 15V	14 ~ 20V	16.8 ~ 24V	18.9 ~ 27V	25.2 ~ 36V	33.6 ~ 48V
	RATED CURRENT	5A	4A	3A	2.5A	2.3A	1.7A	1.3A
	CURRENT RANGE	0 ~ 5A	0 ~ 4A	0 ~ 3A	0 ~ 2.5A	0 ~ 2.3A	0 ~ 1.7A	0 ~ 1.3A
	RATED POWER	60W	60W	60W	60W	62.1W	61W	62.5W
	RIPPLE & NOISE (max.) Note.2	2Vp-p	2.4Vp-p	1.8Vp-p	2.4Vp-p	2.7Vp-p	3.6Vp-p	4.6Vp-p
	VOLTAGE ADJ. RANGE Note.5	11.5 ~ 13V	14.5 ~ 16.2V	19.5 ~ 22V	24 ~ 26V	25 ~ 30V	32.5 ~ 39V	43.6 ~ 51.8V
	CURRENT ADJ. RANGE Note.5	3.75 ~ 5.15A	3 ~ 4.12A	2.25 ~ 3.09A	1.875 ~ 2.575A	1.725 ~ 2.369A	1.275 ~ 1.751A	0.975 ~ 1.339A
	VOLTAGE TOLERANCE Note.3	$\pm 10\%$						
	LINE REGULATION	$\pm 3.0\%$						
	LOAD REGULATION	$\pm 5.0\%$						
SETUP TIME	1500ms / 230VAC 3000ms / 115VAC at full load							
INPUT	VOLTAGE RANGE Note.4	90 ~ 264VAC 127 ~ 370VDC						
	FREQUENCY RANGE	47 ~ 63Hz						
	POWER FACTOR (Typ.)	PF>0.98/115VAC, PF>0.9/230VAC at full load (Please refer to "Power Factor Characteristic" curve)						
	EFFICIENCY (Typ.)	85%	86%	87.5%	87%	88%	89%	89%
	AC CURRENT (Typ.)	0.8A/115VAC 0.4A/230VAC						
	INRUSH CURRENT (max.)	40A/230VAC						
LEAKAGE CURRENT	<0.75mA / 240VAC							
PROTECTION	OVER CURRENT	95 ~ 110% 110% (max)		Protection type : Constant current limiting, recovers automatically after fault condition is removed				
	SHORT CIRCUIT	Hiccup mode, recovers automatically after fault condition is removed.						
	OVER VOLTAGE	13.8 ~ 16V	17.5 ~ 21V	23 ~ 26V	28 ~ 32V	31 ~ 35V	41 ~ 46V	54 ~ 60V
	OVER TEMPERATURE	95°C $\pm 10^\circ\text{C}$ (TSW1) detect on heatsink of power transistor Protection type : Shut down o/p voltage, recovers automatically after temperature goes down						
ENVIRONMENT	WORKING TEMP.	-30 ~ +50°C (Refer to "Derating Curve")						
	WORKING HUMIDITY	20 ~ 95% RH non-condensing						
	STORAGE TEMP., HUMIDITY	-40 ~ +80°C, 10 ~ 95% RH						
	TEMP. COEFFICIENT	$\pm 0.03\%/^\circ\text{C}$ (0 ~ 50°C)						
	VIBRATION	10 ~ 500Hz, 2G 12min./1cycle, period for 72min. each along X, Y, Z axes						
SAFETY & EMC	SAFETY STANDARDS	UL1310 Class 2, TUV EN61347-1, EN61347-2-13, CAN/CSA C22.2 No. 223-M91(except for 48V); J61347-1, J61347-2-13 approved						
	WITHSTAND VOLTAGE	I/P-O/P:3.75KVAC I/P-FG:1.88KVAC O/P-FG:0.5KVAC						
	ISOLATION RESISTANCE	I/P-O/P:100M Ohms / 500VDC / 25°C / 70% RH						
	EMC EMISSION	Compliance to EN55015, EN55022 (CISPR22) Class B, EN61000-3-2 Class C ($\geq 75\%$ load); EN61000-3-3						
	EMC IMMUNITY	Compliance to EN61000-4-2,3,4,5,6,8,11, EN55024, EN61547, light industry level, criteria A						
OTHERS	MTBF	515Khrs min. MIL-HDBK-217F (25°C)						
	DIMENSION	181.5*62*35mm (L*W*H)						
	PACKING	0.41Kg; 30pcs/13.3Kg/0.67CUFT						
NOTE	<ol style="list-style-type: none"> 1. All parameters NOT specially mentioned are measured at 230VAC input, rated load and 25°C of ambient temperature. 2. Ripple & noise are measured at 20MHz of bandwidth by using a 12" twisted pair-wire terminated with a 0.1uF & 47uF parallel capacitor. 3. Tolerance : includes set up tolerance, line regulation and load regulation. 4. Derating may be needed under low input voltage. Please check the static characteristics for more details. 5. Output voltage can be adjusted through the SVR1 on the PCB ; limit of output constant current level can be adjusted through the SVR2 on the PCB. 6. Constant current operation region is within 70% ~100% rated output voltage. This is the suitable operation region for LED related applications, but please reconfirm special electrical requirements for some specific system design. 7. The power supply is considered as a component that will be operated in combination with final equipment. Since EMC performance will be affected by the complete installation, the final equipment manufacturers must re-qualify EMC Directive on the complete installation again. 8. Direct connecting to LEDs is suggested, but is not suitable for using additional drivers. 							



60W Single Output LED Power Supply

PLC-60 series

Mechanical Specification

Case No.991A Unit:mm

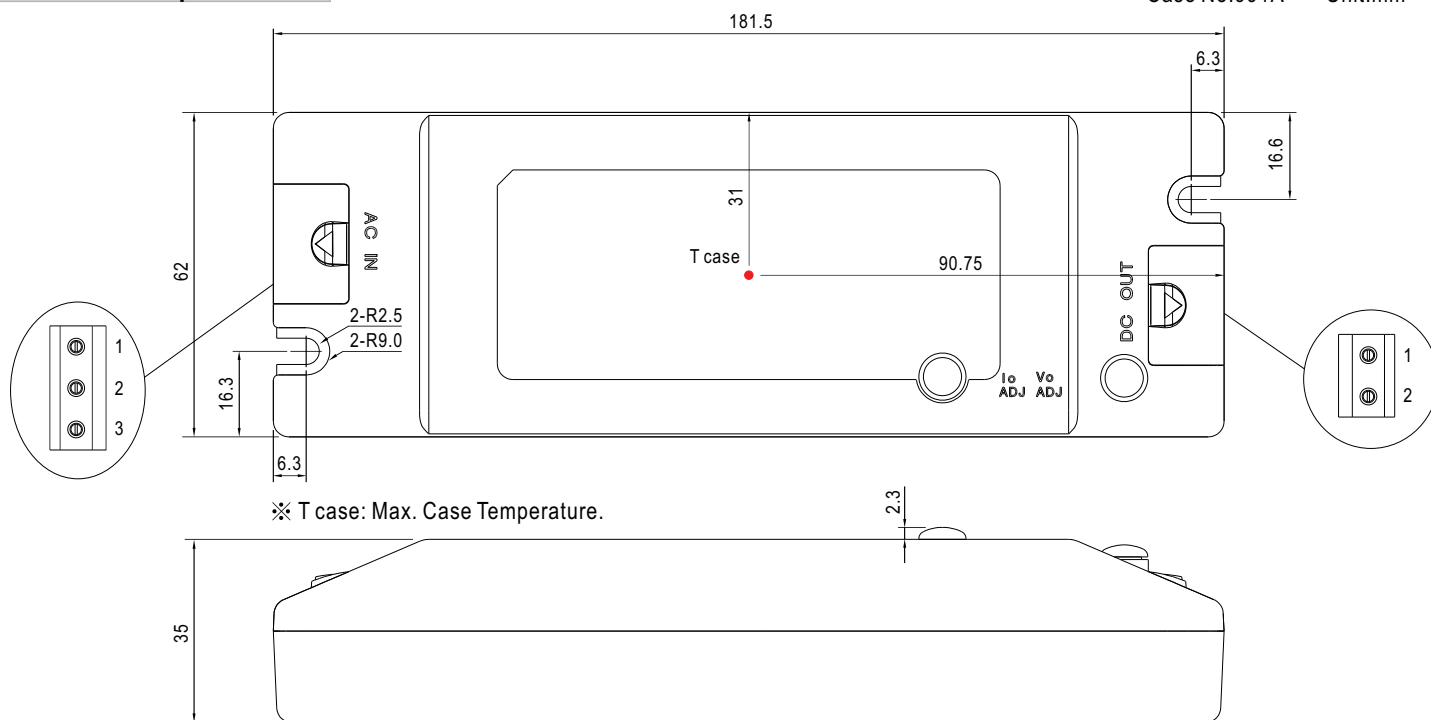

※ T case: Max. Case Temperature.

Terminal Pin No. Assignment (TB1):
SWITCLAB MB310-75003

Pin No.	Assignment
1	AC/L
2	AC/N
3	FG ⊕

Terminal Pin No. Assignment (TB2):
SWITCLAB MB310-75002

Pin No.	Assignment
1	+V
2	-V

Block Diagram

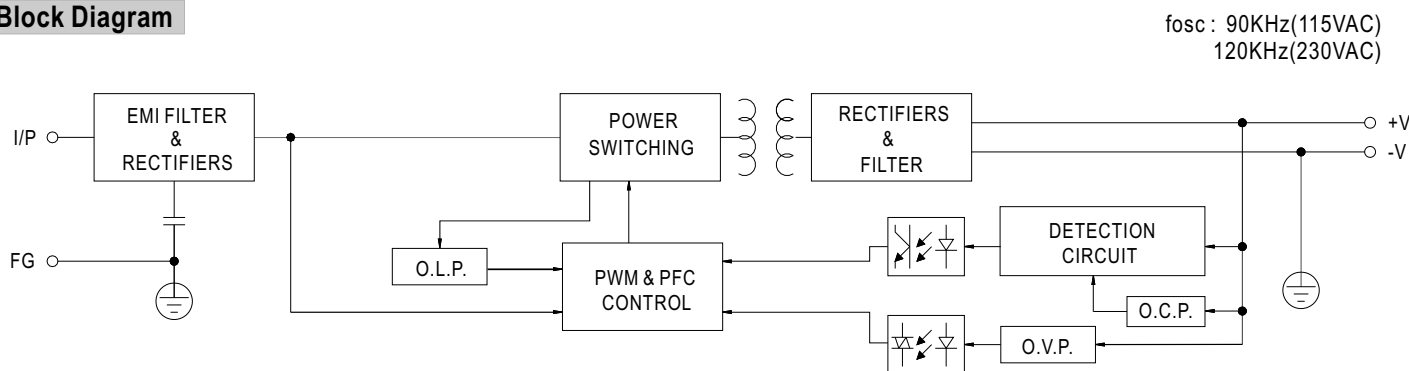

Derating Curve

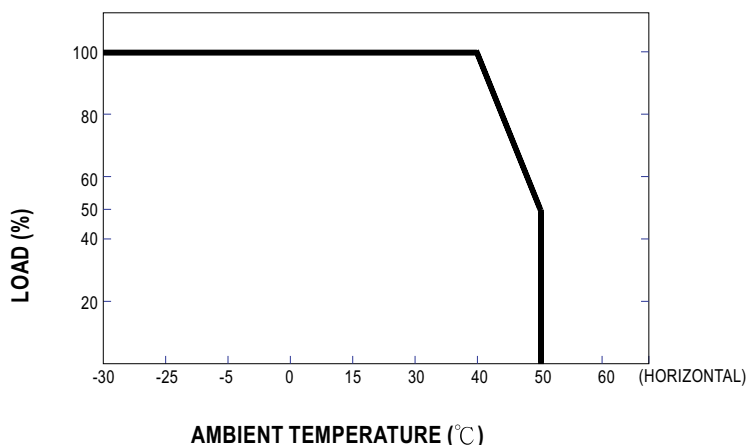

Static Characteristics

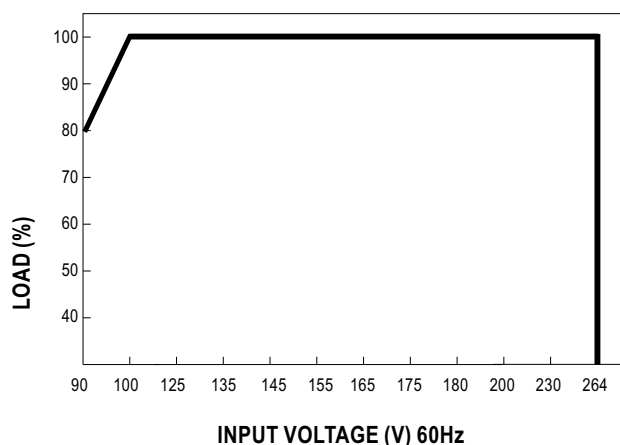



60W Single Output LED Power Supply

PLC-60 series

Power Factor Characteristic

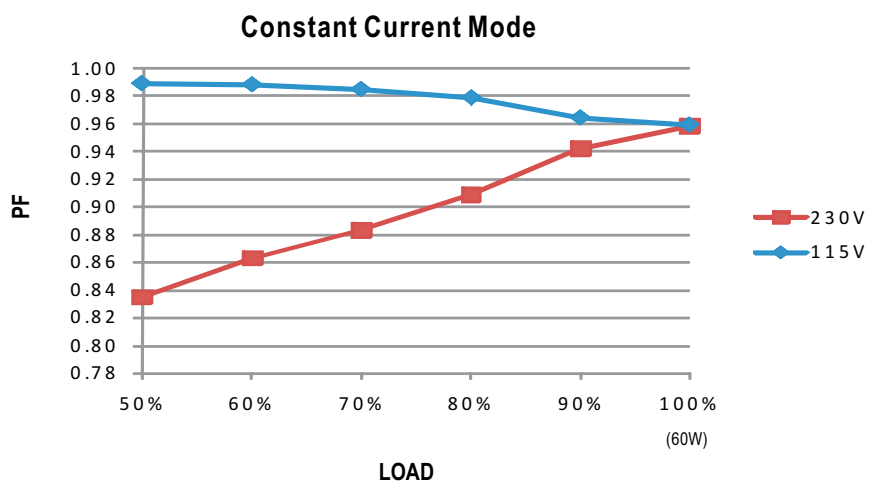

EFFICIENCY vs LOAD (48V Model)

PLC-60 series possess superior working efficiency that up to 89% can be reached in field applications.

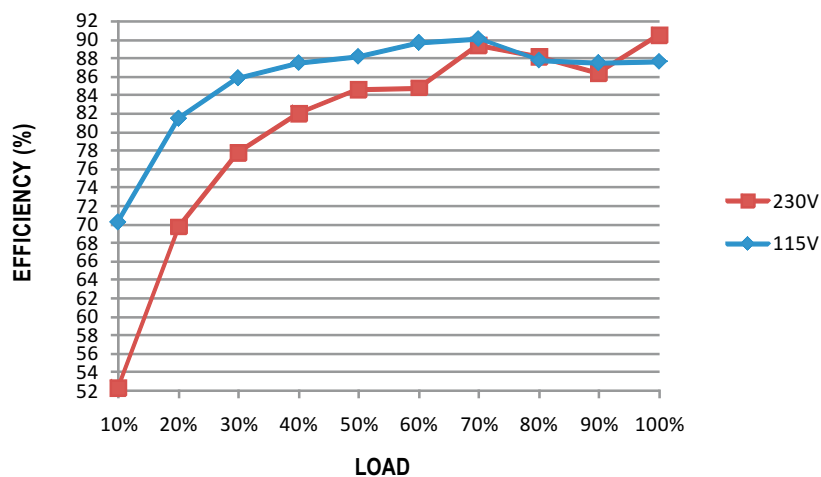

DRIVING METHODS OF LED MODULE

There are two major kinds of LED drive method "direct drive" and "with LED driver".

A typical LED power supply may either work in "constant voltage mode (CV) or constant current mode (CC)" to drive the LEDs.

Mean Well's LED power supply with CV+ CC characteristic can be operated at both CV mode [with LED driver, at area (A)] and CC mode [direct drive, at area (B)].

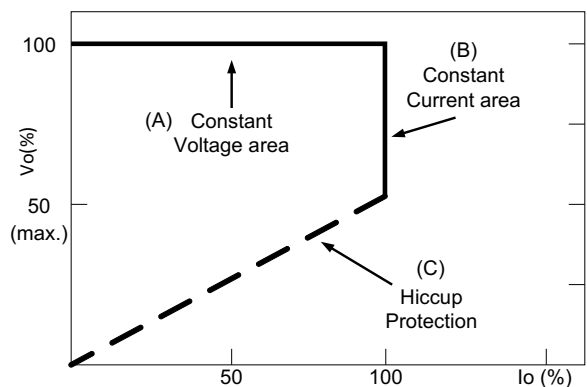

Typical LED power supply I-V curve