

POSEICOPOSEICO SPA
POwer SEmiconductors Italian COrporationPOSEICO SPA
Via N. Lorenzi 8, 16152 Genova - ITALY
Tel. +39 010 6556234 - Fax +39 010 6557519
Sales Office:
Tel. +39 010 6556775 - Fax +39 010 6445141**PHASE CONTROL THYRISTOR****AT708**

Repetitive voltage up to

800 V

Mean on-state current

4925 A

Surge current

70 kA**FINAL SPECIFICATION**

mag 06 - ISSUE : 03

Symbol	Characteristic	Conditions	T _j [°C]	Value	Unit
BLOCKING					
V _{RRM}	Repetitive peak reverse voltage		140	800	V
V _{RSM}	Non-repetitive peak reverse voltage		140	900	V
V _{DRM}	Repetitive peak off-state voltage		140	800	V
I _{RRM}	Repetitive peak reverse current	V=VRRM	140	200	mA
I _{DRM}	Repetitive peak off-state current	V=VDRM	140	200	mA
CONDUCTING					
I _{T(AV)}	Mean on-state current	180° sin, 50 Hz, Th=55°C, double side cooled		4925	A
I _{T(AV)}	Mean on-state current	180° sin, 50 Hz, Tc=85°C, double side cooled		4185	A
I _{TSM}	Surge on-state current	sine wave, 10 ms	140	70	kA
I ² t	I ² t	without reverse voltage		24500 x1E3	A ² s
V _T	On-state voltage	On-state current = 10000 A	25	1,5	V
V _{T(TO)}	Threshold voltage		140	0,84	V
r _T	On-state slope resistance		140	0,060	mohm
SWITCHING					
di/dt	Critical rate of rise of on-state current, min.	From 75% VDRM up to 3900 A, gate 10V 5ohm	140	320	A/μs
dv/dt	Critical rate of rise of off-state voltage, min.	Linear ramp up to 70% of VDRM	140	500	V/μs
t _d	Gate controlled delay time, typical	VD=100V, gate source 10V, 10 ohm, tr=.5 μs	25	3	μs
t _q	Circuit commutated turn-off time, typical	dV/dt = 20 V/μs linear up to 75% VDRM		160	μs
Q _{rr}	Reverse recovery charge	di/dt=-20 A/μs, I= 2600 A	140		μC
I _{rr}	Peak reverse recovery current	VR= 50 V			A
I _H	Holding current, typical	VD=5V, gate open circuit	25	300	mA
I _L	Latching current, typical	VD=5V, tp=30μs	25	1000	mA
GATE					
V _{GT}	Gate trigger voltage	VD=5V	25	3,5	V
I _{GT}	Gate trigger current	VD=5V	25	250	mA
V _{GD}	Non-trigger gate voltage, min.	VD=VDRM	140	0,25	V
V _{FGM}	Peak gate voltage (forward)			30	V
I _{FGM}	Peak gate current			10	A
V _{RGM}	Peak gate voltage (reverse)			5	V
P _{GM}	Peak gate power dissipation	Pulse width 100 μs		150	W
P _G	Average gate power dissipation			2	W
MOUNTING					
R _{th(j-h)}	Thermal impedance, DC	Junction to heatsink, double side cooled		11	°C/kW
R _{th(c-h)}	Thermal impedance	Case to heatsink, double side cooled		2	°C/kW
T _j	Operating junction temperature			-30 / 140	°C
F	Mounting force			40.0 / 50.0	kN
	Mass			1700	g
ORDERING INFORMATION : AT708 S 08					
standard specification <input type="checkbox"/> <input type="checkbox"/> VDRM&VRRM/100					

AT708 PHASE CONTROL THYRISTOR



FINAL SPECIFICATION mag 06 - ISSUE : 03

DISSIPATION CHARACTERISTICS

SQUARE WAVE

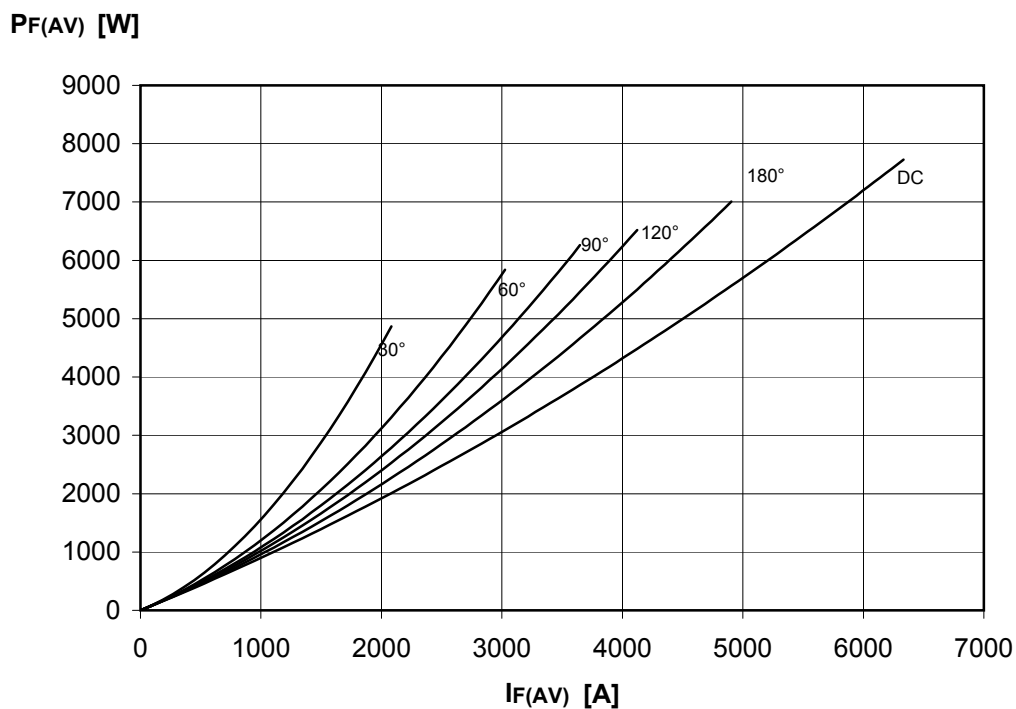
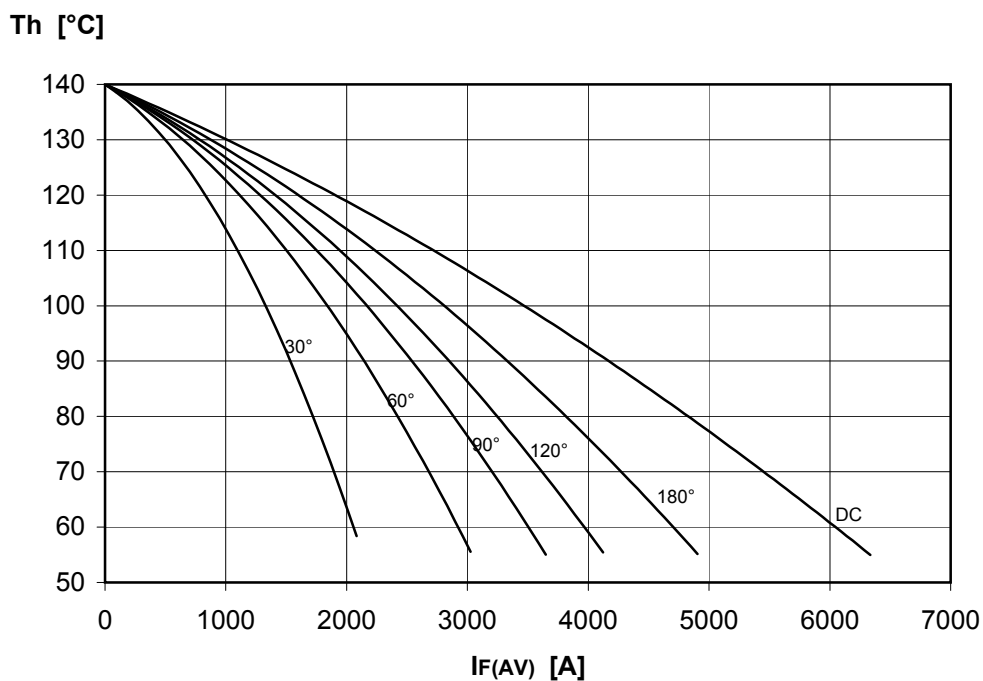

AT708 PHASE CONTROL THYRISTOR

FINAL SPECIFICATION mag 06 - ISSUE : 03

DISSIPATION CHARACTERISTICS

SINE WAVE

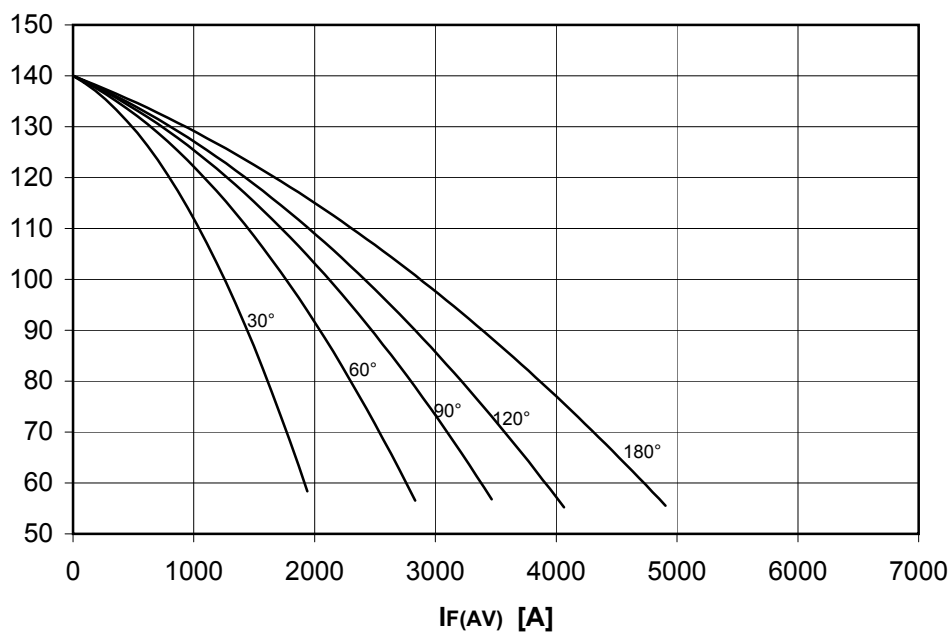
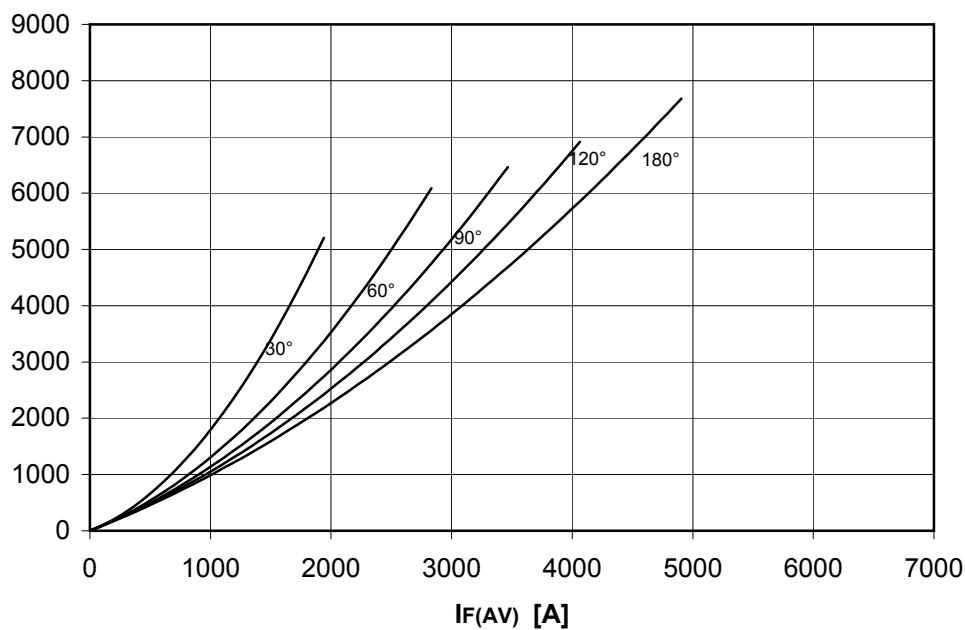
Th [°C]**PF(AV) [W]**

AT708 PHASE CONTROL THYRISTOR



FINAL SPECIFICATION mag 06 - ISSUE : 03

ON-STATE CHARACTERISTIC
T_j = 140 °C

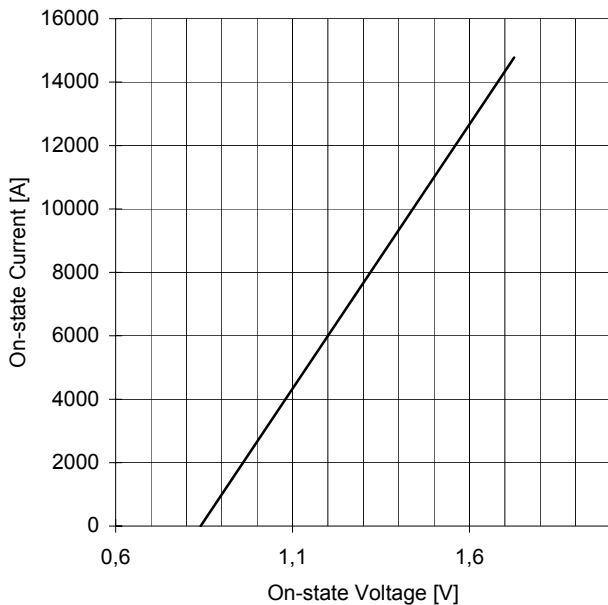

SURGE CHARACTERISTIC
T_j = 140 °C

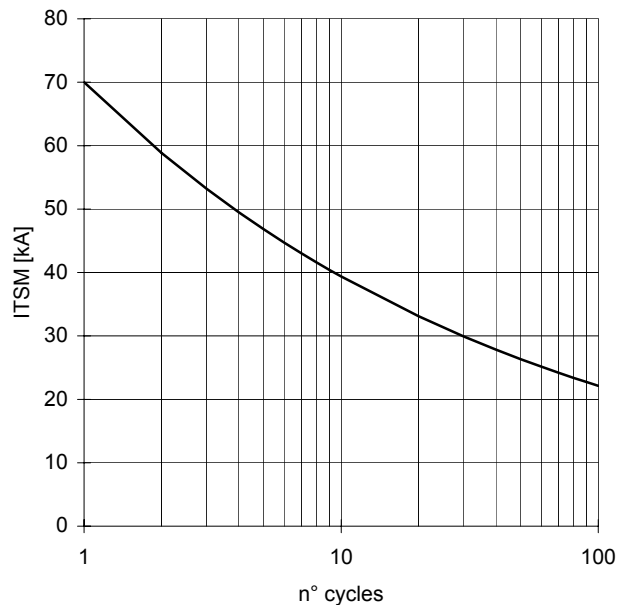

TRANSIENT THERMAL IMPEDANCE
DOUBLE SIDE COOLED

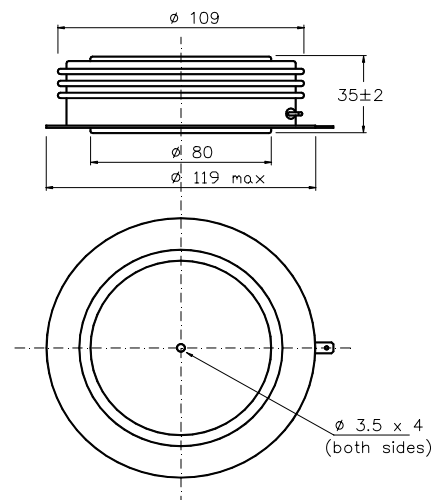
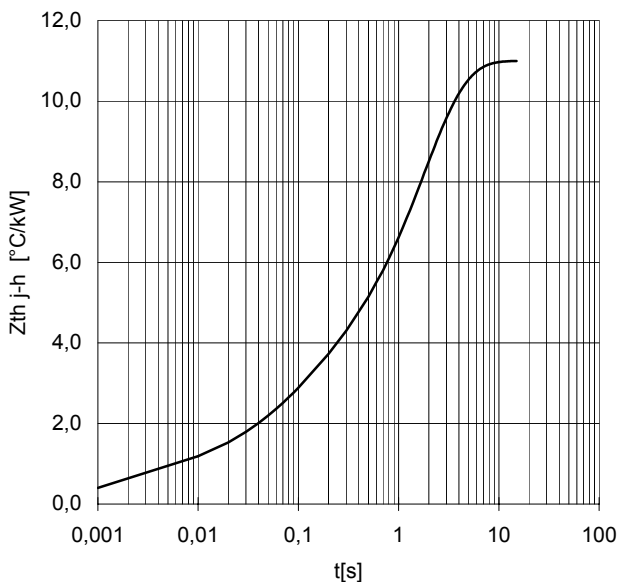

Dimensions in mm



Cathode terminal type DIN 46244 - A 4.8 - 0.8

Gate terminal type AMP 60598 - 1

Distributed by

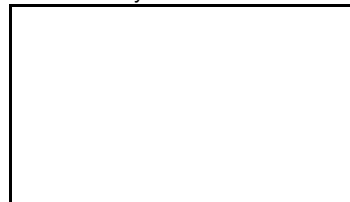

All the characteristics given in this data sheet are guaranteed only with uniform clamping force, cleaned and lubricated heatsink, surfaces with flatness < .03 mm and roughness < 2 μm.

In the interest of product improvement POSEICO reserves the right to change any data given in this data sheet at any time without previous notice.

If not stated otherwise the maximum value of ratings (symbols over shaded background) and characteristics is reported.