

# 7MBR25SA120

## IGBT Modules

### IGBT MODULE (S series) 1200V / 25A / PIM



#### ■ Features

- Low  $V_{CE(sat)}$
- Compact package
- P.C. board mount
- Converter diode bridge, Dynamic brake circuit

#### ■ Applications

- Inverter for motor drive
- AC and DC servo drive amplifier
- Uninterruptible power supply

#### ■ Maximum ratings and characteristics

● Absolute maximum ratings ( $T_c=25^\circ\text{C}$  unless without specified)

Item	Symbol	Condition	Rating	Unit		
Inverter	Collector-Emitter voltage	$V_{CES}$	1200	V		
	Gate-Emitter voltage	$V_{GES}$	$\pm 20$	V		
	Collector current	$I_C$	Continuous	$T_c=25^\circ\text{C}$	35	A
				$T_c=80^\circ\text{C}$	25	
		$I_{CP}$	1ms	$T_c=25^\circ\text{C}$	70	A
				$T_c=80^\circ\text{C}$	50	
$-I_C$			25	A		
Collector power dissipation	$P_C$	1 device	180	W		
Brake	Collector-Emitter voltage	$V_{CES}$	1200	V		
	Gate-Emitter voltage	$V_{GES}$	$\pm 20$	V		
	Collector current	$I_C$	Continuous	$T_c=25^\circ\text{C}$	25	A
				$T_c=80^\circ\text{C}$	15	
		$I_{CP}$	1ms	$T_c=25^\circ\text{C}$	50	A
				$T_c=80^\circ\text{C}$	30	
Collector power dissipation	$P_C$	1 device	110	W		
Repetitive peak reverse voltage	$V_{RRM}$		1200	V		
Converter	Repetitive peak reverse voltage	$V_{RRM}$	1600	V		
	Average output current	$I_O$	50Hz/60Hz sine wave	25	A	
	Surge current (Non-Repetitive)	$I_{FSM}$	$T_j=150^\circ\text{C}$ , 10ms	260	A	
	$I^2t$ (Non-Repetitive)	$I^2t$	half sine wave	338	$\text{A}^2\text{s}$	
Operating junction temperature	$T_j$		+150	$^\circ\text{C}$		
Storage temperature	$T_{stg}$		-40 to +125	$^\circ\text{C}$		
Isolation voltage	between terminal and copper base *2 between thermistor and others *3	$V_{iso}$	AC : 1 minute	AC 2500	V	
				AC 2500		
Mounting screw torque			3.5 *1	N-m		

\*1 Recommendable value : 2.5 to 3.5 N-m (M5)

\*2 All terminals should be connected together when isolation test will be done.

\*3 Terminal 8 and 9 should be connected together. Terminal 1 to 7 and 10 to 24 should be connected together and shorted to copper base.

# IGBT Modules

# 7MBR25SA120

## ● Electrical characteristics (Tj=25°C unless otherwise specified)

Item	Symbol	Condition	Characteristics			Unit			
			Min.	Typ.	Max.				
Inverter	Zero gate voltage collector current	ICES	VCE=1200V, VGE=0V			1.0	mA		
	Gate-Emitter leakage current	IGES	VCE=0V, VGE=±20V			0.2	µA		
	Gate-Emitter threshold voltage	VGE(th)	VCE=20V, Ic=25mA			5.5	7.2	8.5	V
	Collector-Emitter saturation voltage	VCE(sat)	VGE=15V, Ic=25A	chip	2.1		V		
				terminal	2.2			2.6	
	Input capacitance	Cies	VGE=0V, VCE=10V, f=1MHz			3000		pF	
	Turn-on time	ton	VCC=600V			0.35	1.2	µs	
		tr	Ic=25A			0.25	0.6		
		tr(i)	VGE=±15V			0.1			
	Turn-off	toff	RG=51Ω			0.45	1.0		
tf					0.08	0.3			
Forward on voltage	VF	IF=25A	chip	2.3		V			
			terminal	2.4			3.2		
Reverse recovery time of FRD	trr	IF=25A				0.35	µs		
Brake	Zero gate voltage collector current	ICES	VCEs=1200V, VGE=0V			1.0	mA		
	Gate-Emitter leakage current	IGES	VCE=0V, VGE=±20V			0.2	µA		
	Collector-Emitter saturation voltage	VCE(sat)	Ic=15A, VGE=15V	chip	2.1		V		
				terminal	2.2			2.6	
	Turn-on time	ton	VCC=600V			0.35	1.2	µs	
		tr	Ic=15A			0.25	0.6		
	Turn-off time	toff	VGE=±15V			0.45	1.0		
		tf	RG=82Ω			0.08	0.3		
	Reverse current	Irrm	VR=1200V				1.0	mA	
	Forward on voltage	VFM	IF=25A	chip	1.1		V		
terminal				1.2		1.5			
Reverse current	Irrm	VR=1600V				1.0	mA		
Thermistor	Resistance	R	T=25°C			5000		Ω	
			T=100°C			465	495		520
	B value	B	T=25/50°C			3305	3375	3450	K

## ● Thermal resistance Characteristics

Item	Symbol	Condition	Characteristics			Unit
			Min.	Typ.	Max.	
Thermal resistance ( 1 device )	Rth(j-c)	Inverter IGBT			0.69	°C/W
		Inverter FWD			1.30	
		Brake IGBT			1.14	
		Converter Diode			0.90	
Contact thermal resistance *	Rth(c-f)	With thermal compound		0.05		

\* This is the value which is defined mounting on the additional cooling fin with thermal compound

## ■ Equivalent Circuit Schematic

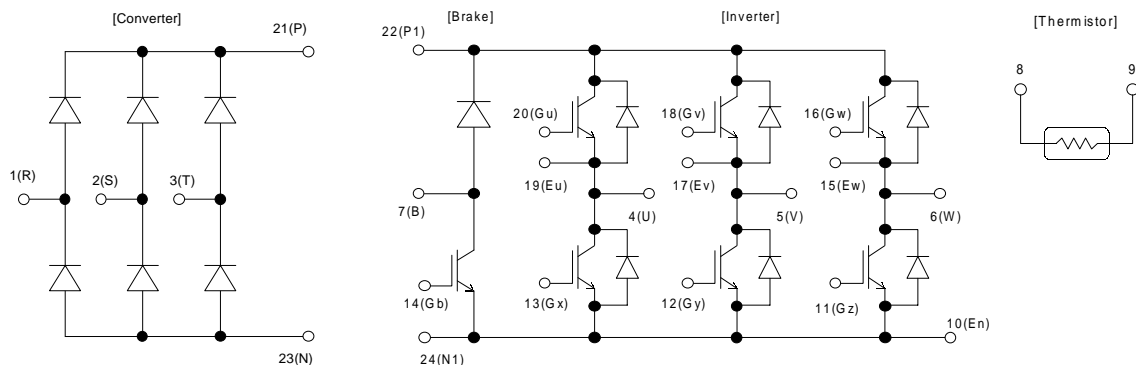

# IGBT Modules

# 7MBR25SA120

## Characteristics (Representative)

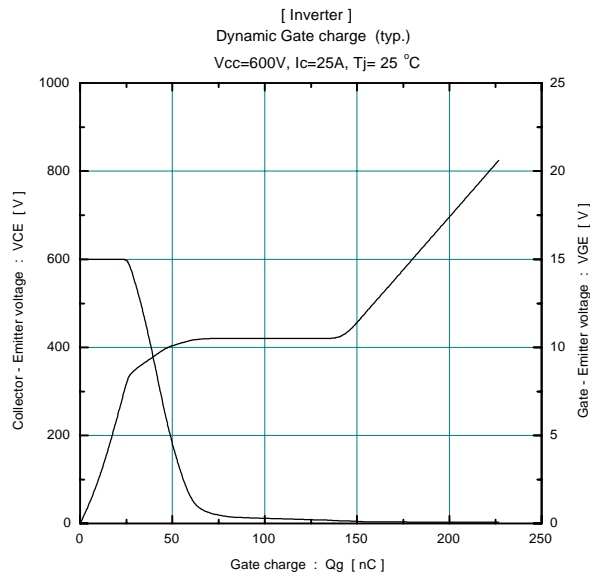
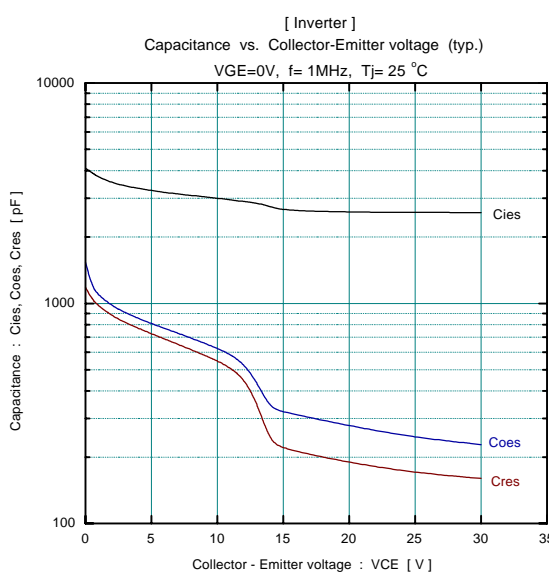
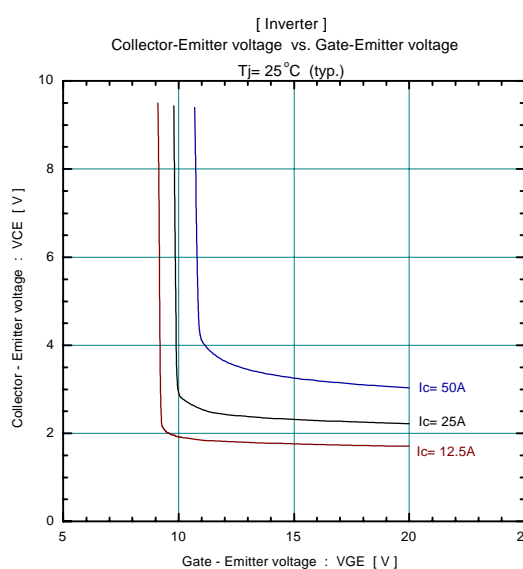
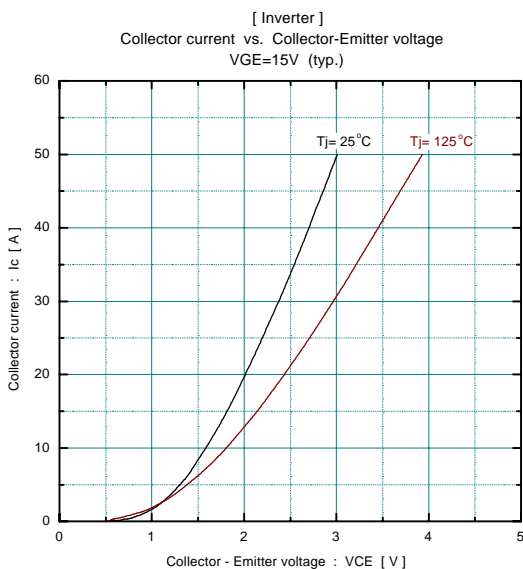
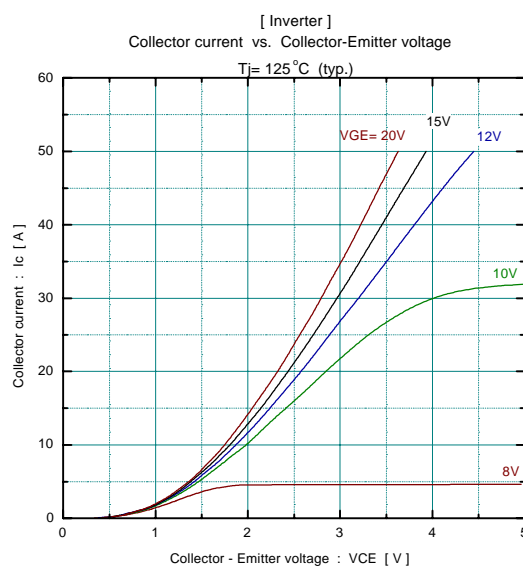
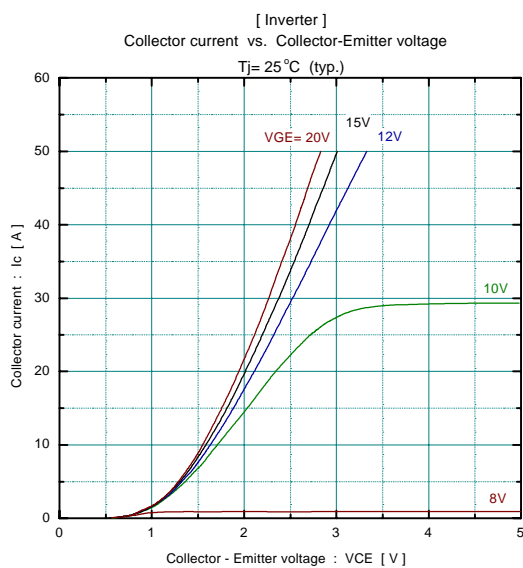

# IGBT Modules

# 7MBR25SA120

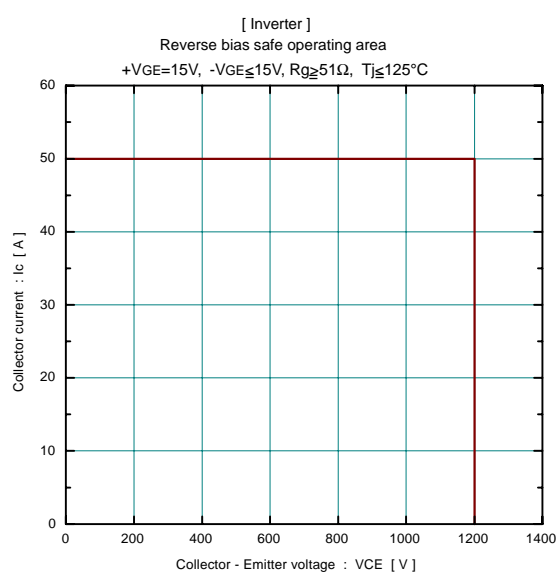
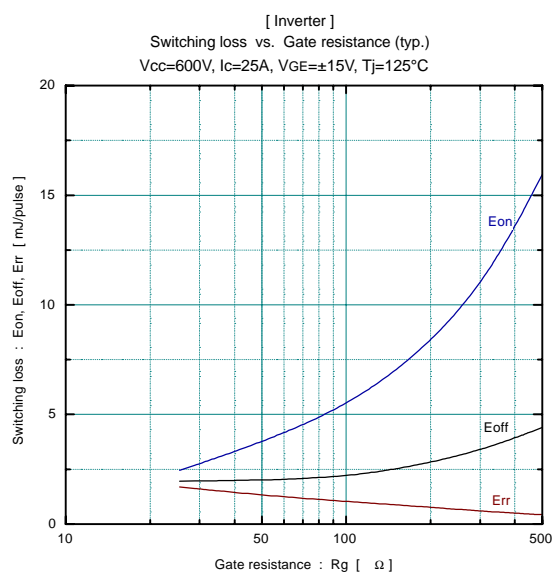
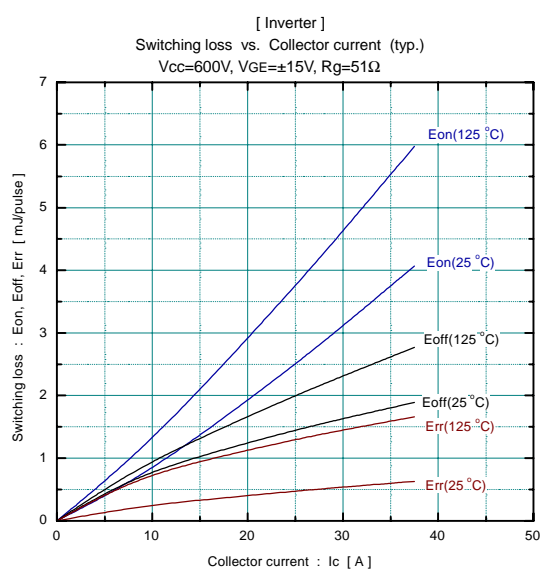
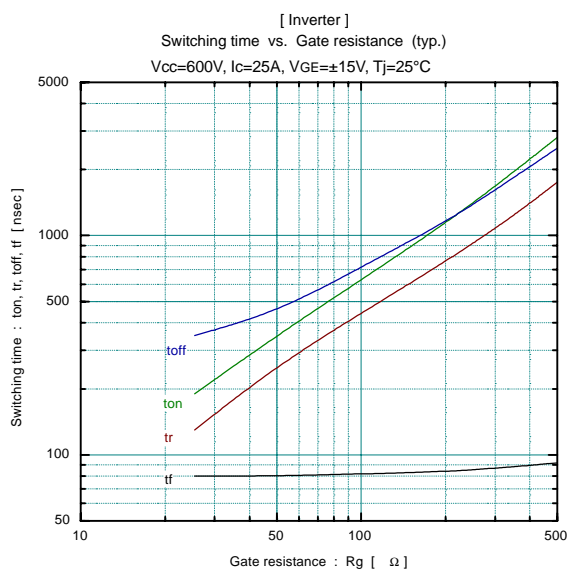
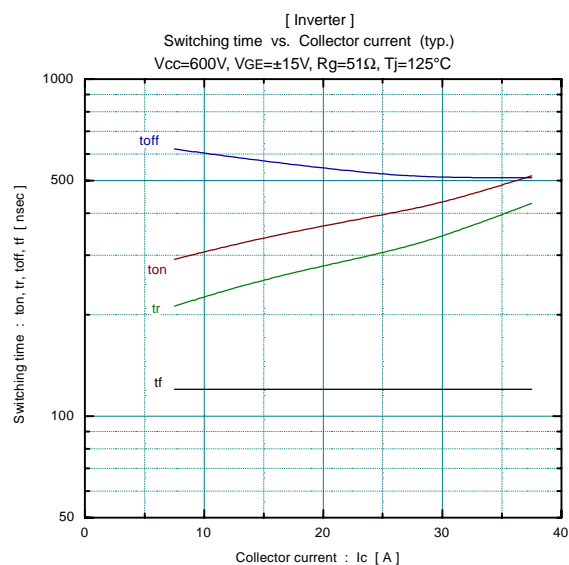
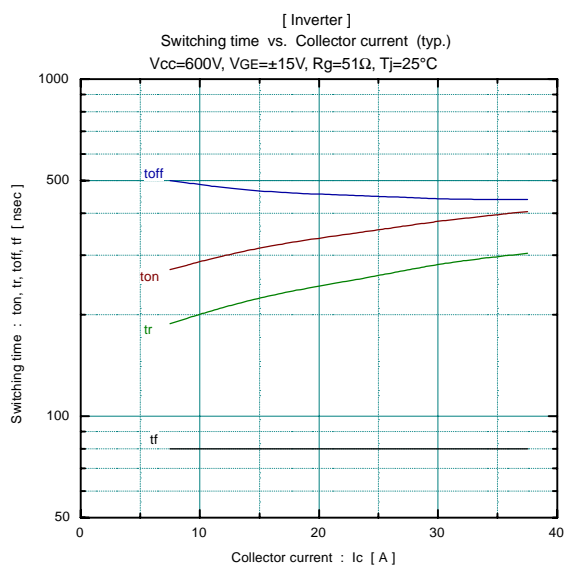

# IGBT Modules

# 7MBR25SA120

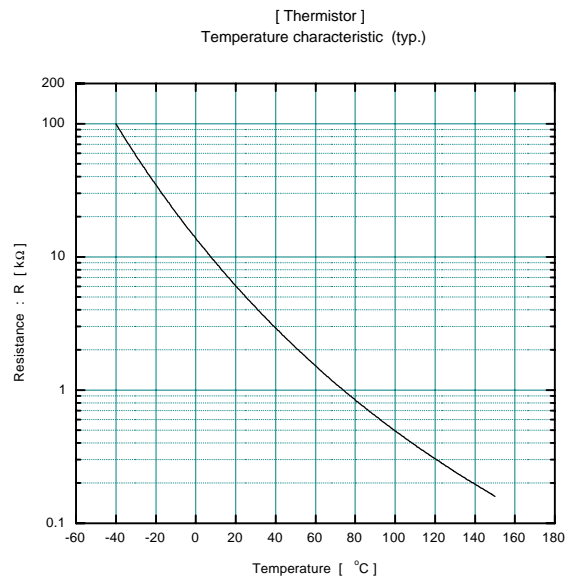
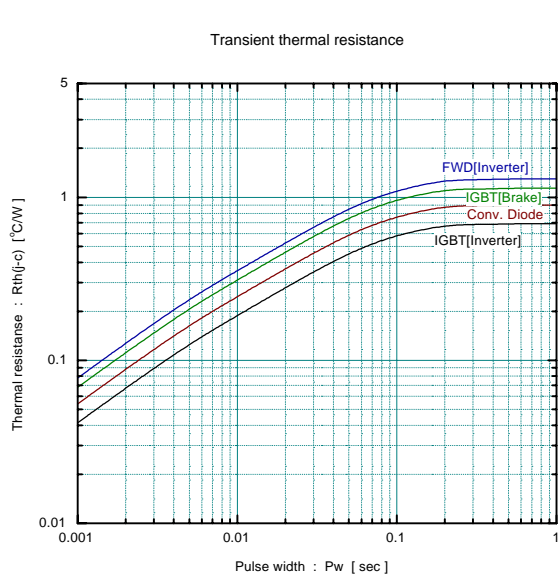
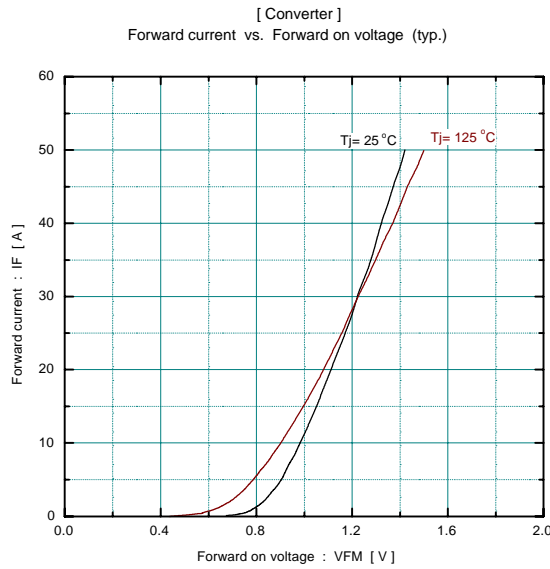
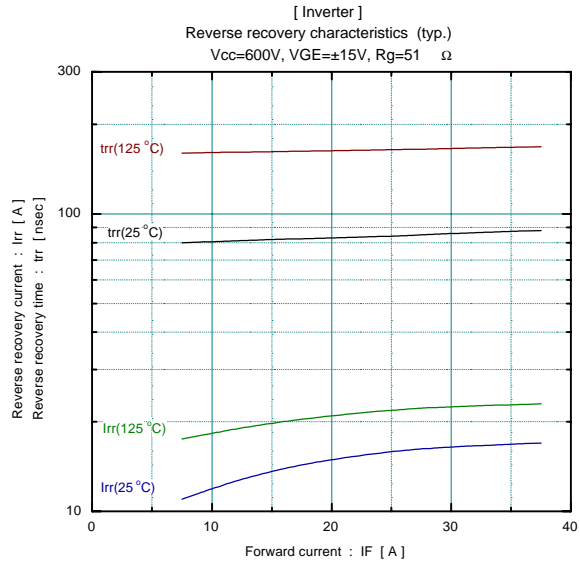
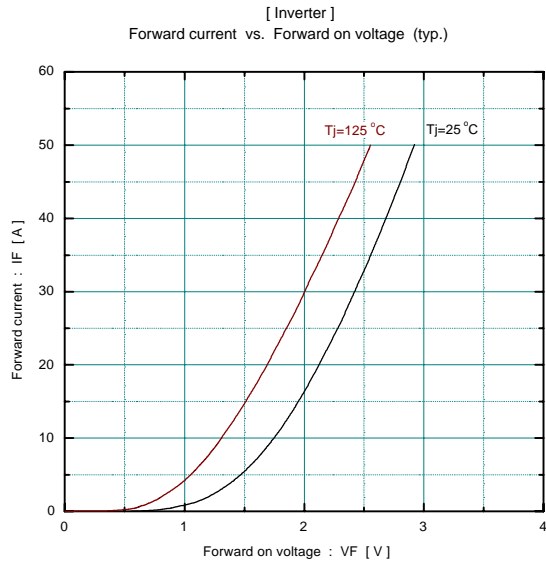

# IGBT Modules

# 7MBR25SA120

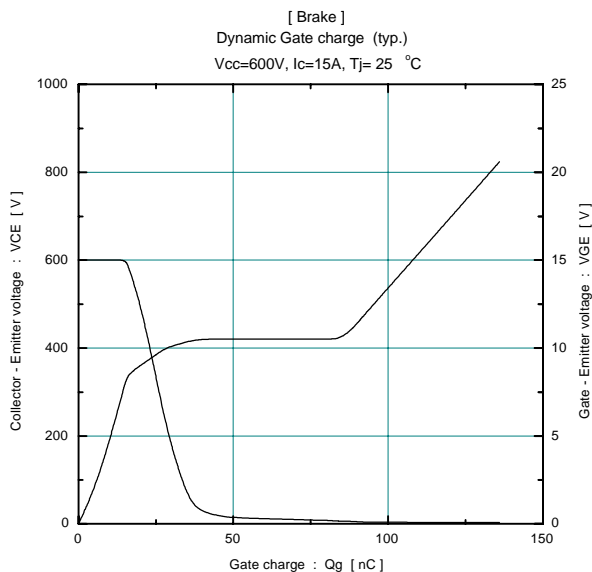
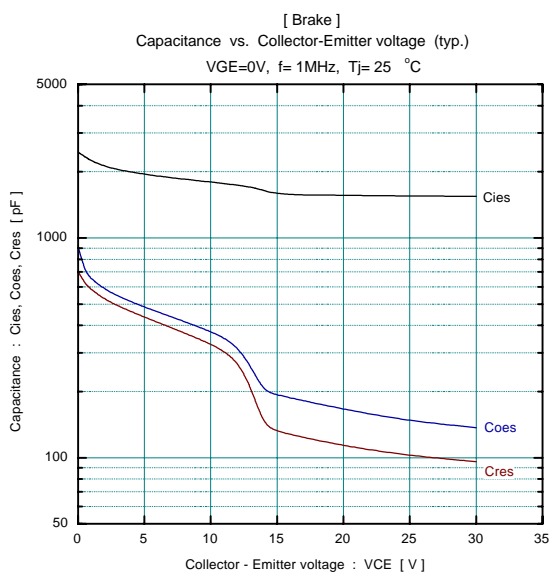
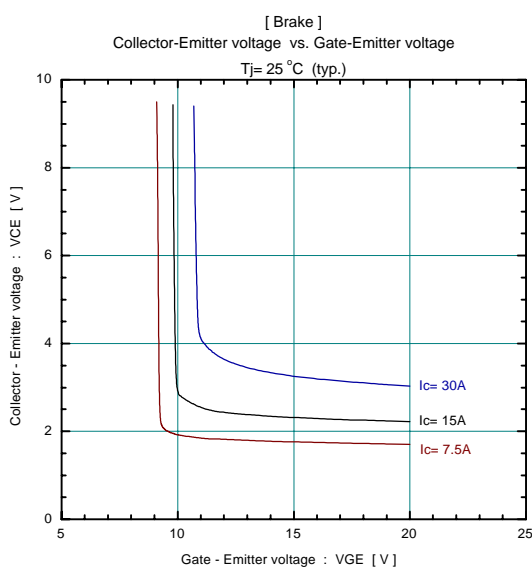
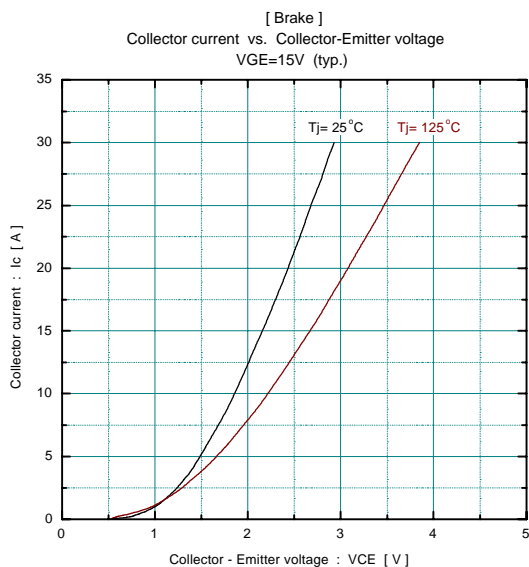
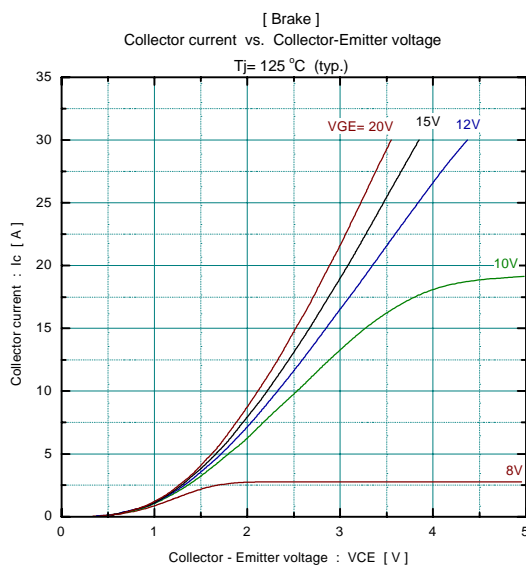
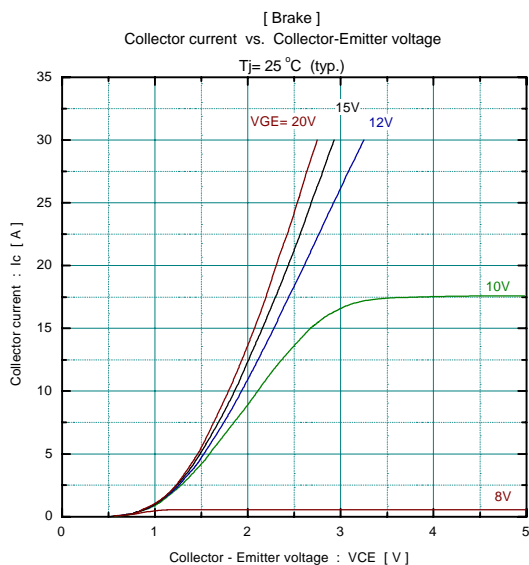

# IGBT Modules

# 7MBR25SA120

## ■ Outline Drawings, mm

