



2RI 100G-120/160

2-Pack Diode
1200/1600 V
100 A

POWER DIODE MODULE

Features

- All the terminals and the mounting plate are electrically isolated. These modules can be installed in the same cooling fin as other modules, thus saving installation space – a cost-effective feature.
- The diode chips are coated with a glass of zinc oxide, making them highly resistant to temperature and humidity variation.
- Two diodes chips are connected in series internally, so allowing the rectifying circuit to be simplified.

Applications

- Inverters for AC motors
- Power supply units for DC motors
- DC power supply units for battery chargers
- General purpose DC power supply units

Outline Drawings

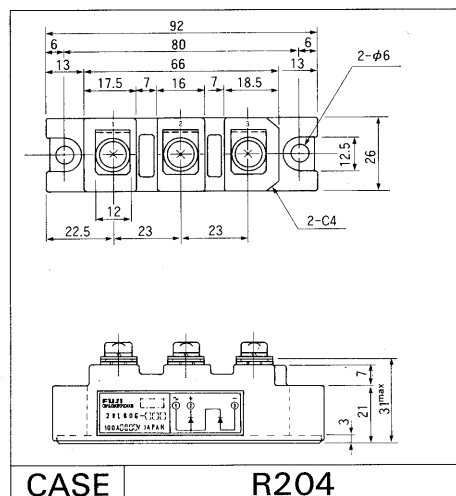

CASE R204

Inner Circuit Schematic

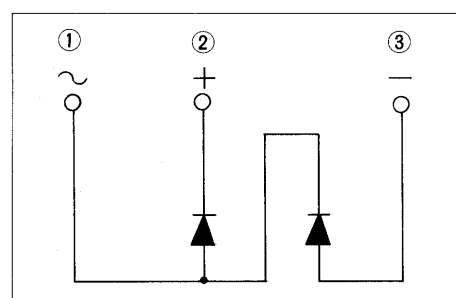

Maximum Ratings and Characteristics

Absolute Maximum Ratings

Items	Symbols	Conditions	2RI100G		Units
			-120	-160	
Repetitive peak reverse voltage	V_{RRM}		1200	1600	V
Non-repetitive peak reverse voltage	V_{RSM}		1320	1760	V
Average forward current	$I_{F(AV)}$	50/60 Hz Sinewave, $T_C = 98^\circ\text{C}$	2 × 100		A
Surge current	I_{FSM}	Rated load conditions, 10 ms	1200		A
I_t^2	I_t^2	Rated load conditions	16000		A ² s
Junction temperature	T_j		-40 ~ +150		°C
Storage temperature	T_{stg}		-40 ~ +125		°C
Tightening torque		Mounting screw: M5	25 ± 5		kg.cm
Vibration resistance			5		G
Dielectric strength		Between terminals and base	2500 VAC 1min		
Net. Weight			180		g

Electrical Characteristics

Items	Symbols	Conditions	Min	Typ	Max	Units
Forward voltage	V_{FM}	$T_j = 25^\circ\text{C}$, $I_{FM} = 320\text{ A}$			1.40	V
Reverse current	I_{RRM}	$T_j = 150^\circ\text{C}$, $V_R = V_{RRM}$			30	mA

Thermal Characteristics

Items	Symbols	Conditions	Min	Typ	Max	Units
Thermal resistance (Junction to case)	$R_{th(j-c)}$	50/60 Hz Sinewave, Thermal resistance for total loss			0.20	°C/W
Thermal resistance	$R_{th(c-f)}$	With thermal compound			0.10	°C/W



2R1 100G-120/160

2-Pack Diode
1200/1600 V
100 A

■ Characteristic curves

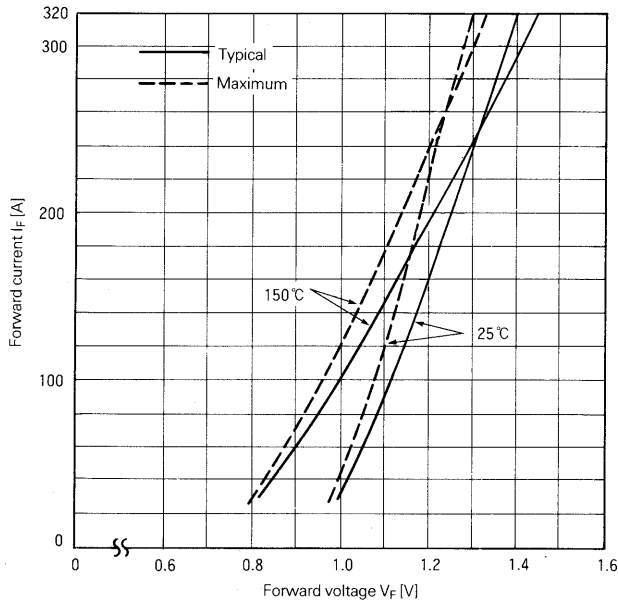

Forward Characteristics

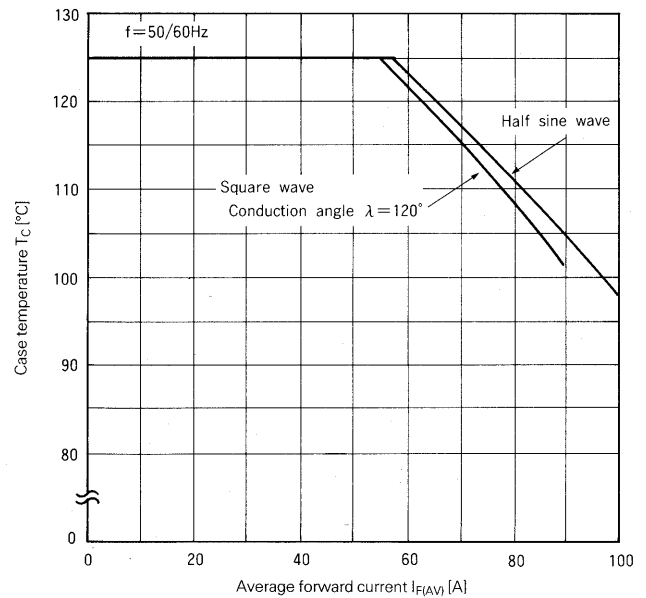

Case Temperature vs. Average Forward Current

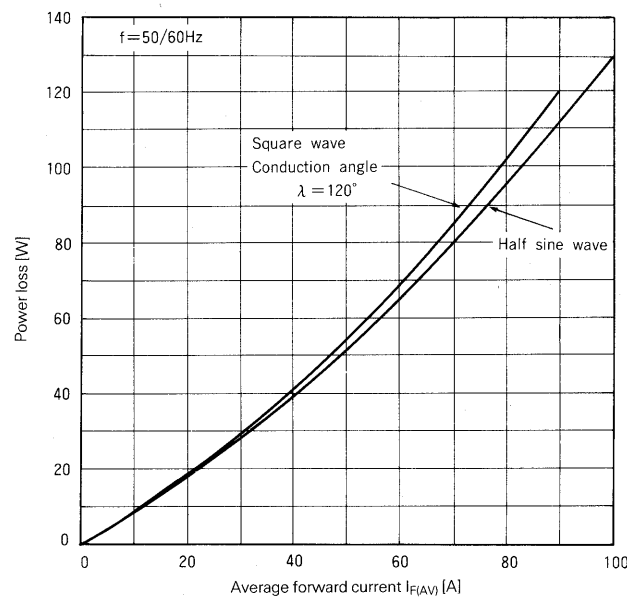

Power Loss vs. Average Forward Current



2R1 100G-120/160

2-Pack Diode
1200/1600 V
100 A

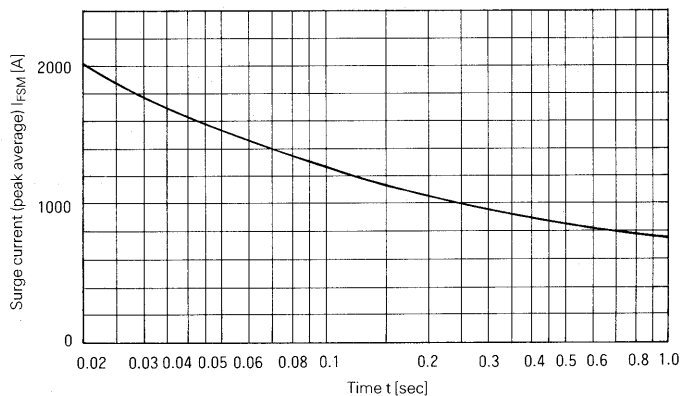

Surge Current

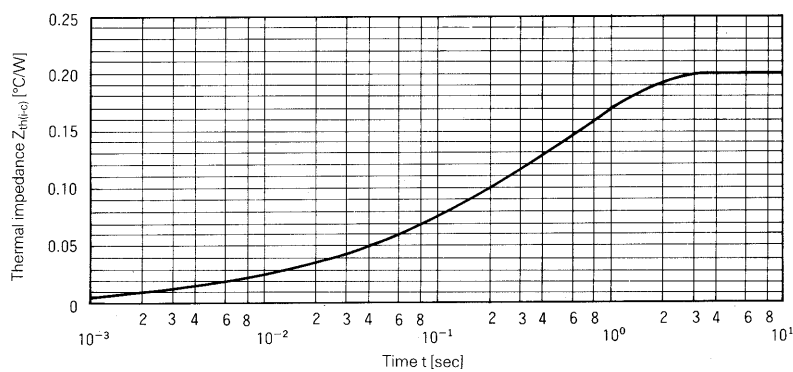

Transient Thermal Impedance

For more information, contact:

Collmer Semiconductor, Inc.

P.O. Box 702708

Dallas, TX 75370

972-733-1700

972-381-9991 Fax

<http://www.collmer.com>