



2R1 100E-060/080

2-Pack Diode
600/800 V
100 A

POWER DIODE MODULE

Features

- All the terminals and the mounting plate are electrically isolated. These modules can be installed in the same cooling fin as other modules, thus saving installation space – a cost-effective feature.
- The diode chips are coated with a glass of zinc oxide, making them highly resistant to temperature and humidity variation.
- Two diodes chips are connected in series internally, so allowing the rectifying circuit to be simplified.

Applications

- Inverters for AC motors
- Power supply units for DC motors
- DC power supply units for battery chargers
- General purpose DC power supply units

Outline Drawings

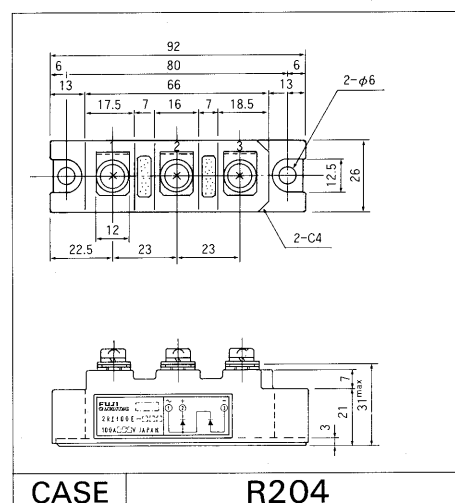

Inner Circuit Schematic

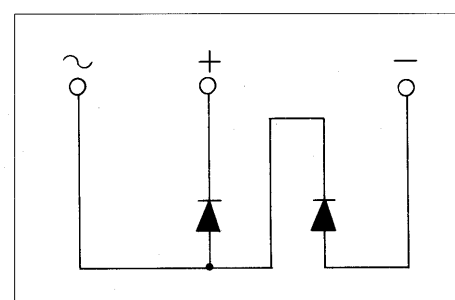

Maximum Ratings and Characteristics

Absolute Maximum Ratings

Items	Symbols	Conditions	2R100E		Units
			-060	-080	
Repetitive peak reverse voltage	V_{RRM}		600	800	V
Non-repetitive peak reverse voltage	V_{RSM}		660	880	V
Average forward current	$I_{F(AV)}$	50/60 Hz Sinewave, $T_C = 103^\circ\text{C}$	2 × 100		A
Surge current	I_{FSM}	Rated load conditions	2000		A
I^2t	I^2t	Rated load conditions	16000		A ² s
Junction temperature	T_j		-40 ~ +150		°C
Storage temperature	T_{stg}		-40 ~ +150		°C
Tightening torque		Mounting screw: M5	25 ± 5		kg·cm
Vibration resistance			5		G
Dielectric strength		Between terminals and base	2000 VAC 1min		
Net. Weight			180		g

Electrical Characteristics

Items	Symbols	Conditions	Min	Typ	Max	Units
Forward voltage	V_{FM}	$T_j = 25^\circ\text{C}$, $I_{FM} = 320\text{ A}$			1.30	V
Reverse current	I_{RRM}	$T_j = 150^\circ\text{C}$, $V_R = V_{RRM}$			20	mA

Thermal Characteristics

Items	Symbols	Conditions	Min	Typ	Max	Units
Thermal resistance (Junction to case)	$R_{th(j-c)}$	50/60 Hz Sinewave, Thermal resistance for total loss			0.20	°C/W
Thermal resistance	$R_{th(c-f)}$	With thermal compound			0.10	°C/W



2R1 100E-060/080

2-Pack Diode
600/800 V
100 A

■ Characteristic curves

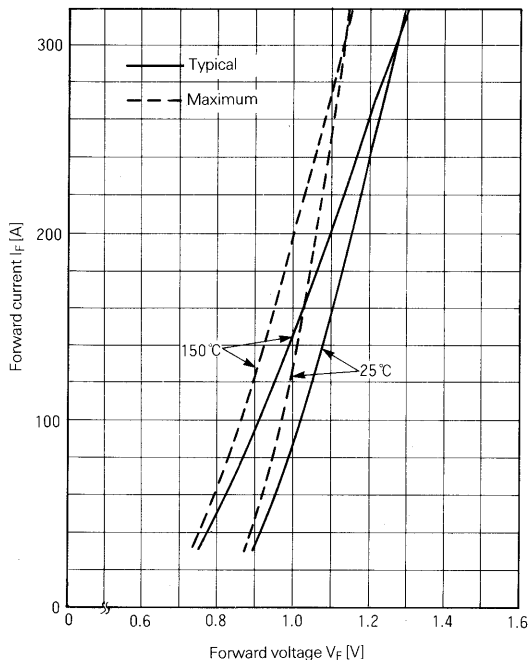

Forward Characteristics

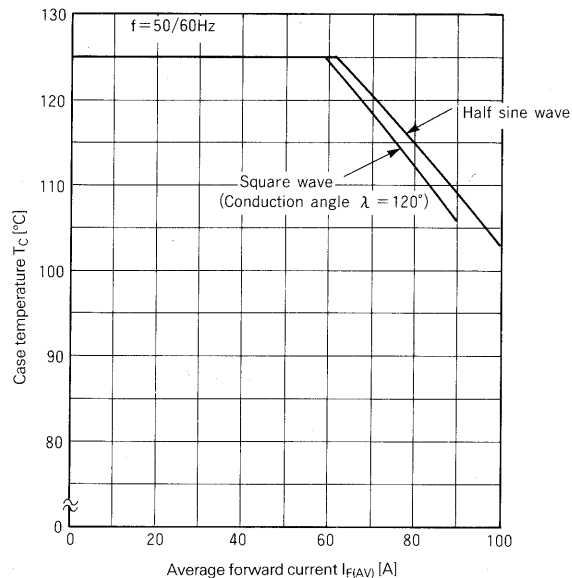

Case Temperature — Forward Average Current

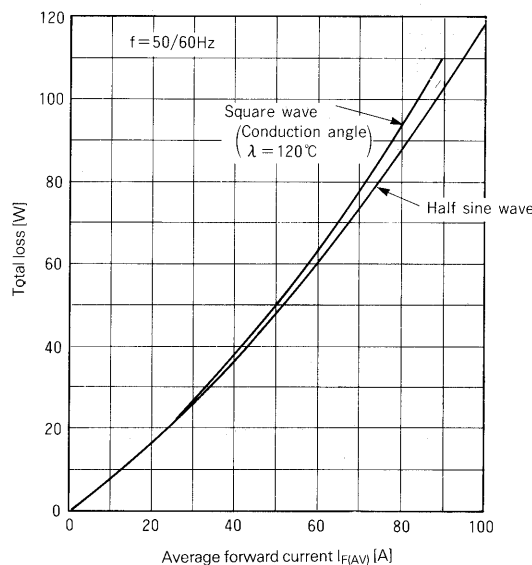

Power Loss — Forward Average Current



2R1 100E-060/080

2-Pack Diode
600/800 V
100 A

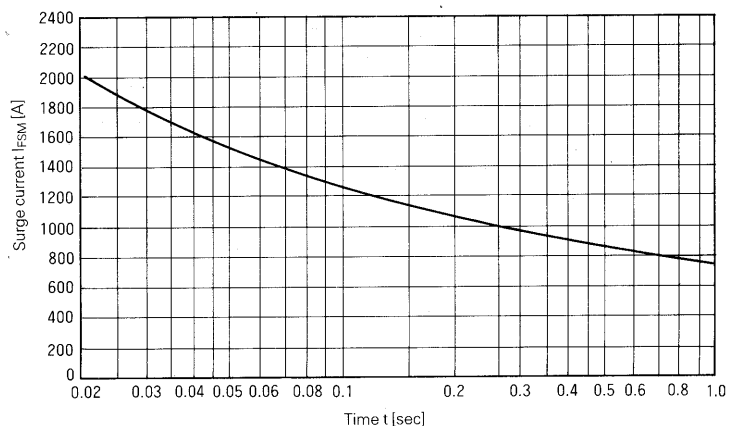

Surge Current

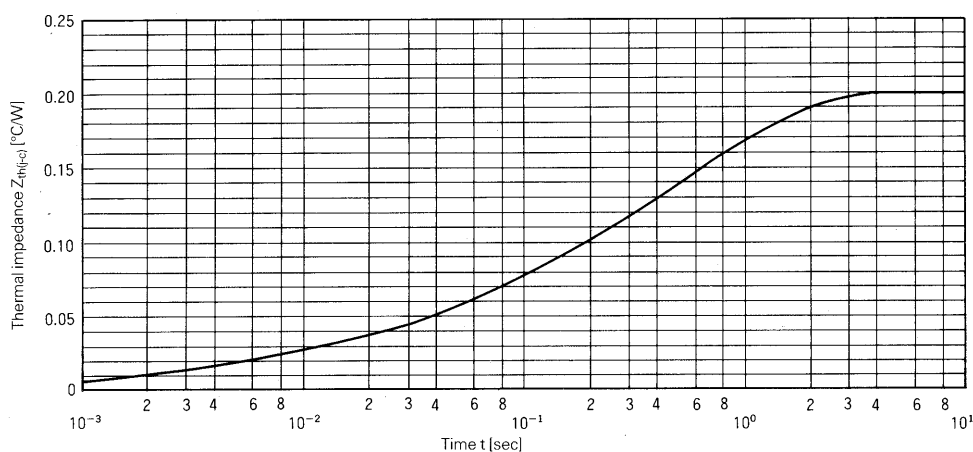

Transient Thermal Impedance

For more information, contact:

Collmer Semiconductor, Inc.

P.O. Box 702708

Dallas, TX 75370

972-733-1700

972-381-9991 Fax

<http://www.collmer.com>