

## Low Voltage Fuse-Links

Предлагаем предохранители  
вставки плавкие  
(радиодетали) СО СКЛАДА И ПОД ЗАКАЗ  
Беларусь г.Минск тел./факс 8(017)200-56-46  
www.fotorele.net e:mail minsk17@tut.by

**Industrial Fuse-Links:** Comply with the dimensional requirements and current ratings of BS88: Part 2, IEC 60269-2 and EN 60269-2. Ranges are available for 400/415V a.c. and 660/690V a.c.

**Compact Dimension Fuse-Links:** With offset blade tags this range meets the requirements of BS88: Part 6 and IEC 60269-2 at rated voltages of 230/240V a.c. and 400/415V a.c.

**General Purpose Fuse-Links:** The popular Lawson type MD cylindrical style fuse-links are rated at 400/415V a.c. and are approved to BS88: Part 1 and IEC 60269-1. They also meet the performance requirements of BS88: Part 2, IEC 60269-2 and EN 60269-2.

**Motor Circuit Fuse-Links:** To accommodate motor starting currents, motor circuit protection fuse-links are available to extend the range of standard fuse-links.

**Additional Tag Forms:** BS88 industrial and motor circuit fuse-links are available with special tags, including those designed to fit ARTIC and REYROLLE pattern fusegear.

**Utility Fuse-Links:** Type J fuse-links for electricity supply networks comply with BS88: Part 5, meet the requirements of the corresponding draft IEC 60269-2 document and also comply with UK Electricity Supply Industry Standards. Fuse-links complying with the requirements of BS1361 are available for both house service cut-outs and consumer units. In addition BS1362 domestic plug fuse-links are also available which meet the requirements of IEC60269-3.

**Street Lighting Fuse-Links:** Type LST 230/240V a.c. fuse-links for street lighting cut-outs comply with BS88: Part 1 and IEC 60269-1. These fuse-links, with a breaking capacity of 20kA at 240V a.c., offer excellent protection and meet the requirements of UK Electricity Supply Industry Standards and BS7654.

**DIN Standard Fuse-Links:** Type LSPN 500V a.c. fuse-links for industrial usage comply with IEC 60269-2. This range is complemented by Type D 500V a.c. fuse-links to IEC 60269-3 (DIN-VDE 0636-41) and Type DO 400V a.c. fuse-links to IEC 60269-3 (DIN-VDE 0636-31).

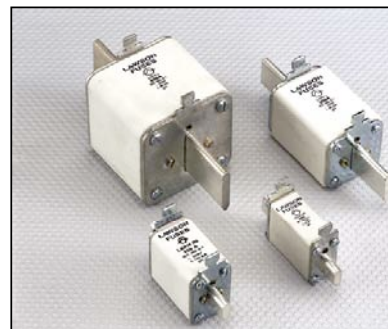
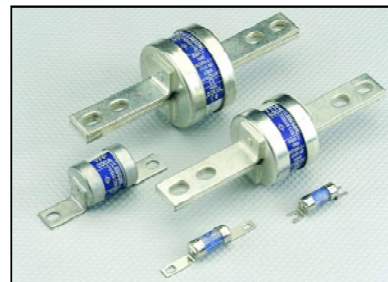

# Lawson Low Voltage Fuse-Links

# Index

Industrial Fuse-Links with Bolted Tags -400/415V

Industrial Fuse-Links with Bolted Tags -660/690V

Compact Dimension Fuse-Links

Street Lighting Fuse-Links

Dual Rated Fuse-Links for Motor Circuit Protection

DIN NH - Bottle D and DO

Additional Fuse-Link Types

Electricity Supply Fuse-Links

Artic & Reyrolle Pattern Fuse-Links

Cylindrical Fuse-Links

Miniature Fuse-Links

Fuse-Link Characteristics

Application Data



## Quality

Lawson Fuses operates a Quality Management System which has been independently assessed and approved by ASTA Certification Services as complying with ISO 9001 and is supported by the issue of Certificate No. 11050. Lawson manufactured fuse-links have been independently certified by ASTA and where appropriate comply with the the rules of the latest ASTA 20 Scheme, which authorises Lawson Fuses to endorse those products "ASTA (20) CERT"

For details of products other than Low Voltage Fuse-Links, please ask for other publications.



**INDUSTRIAL FUSE-LINKS WITH BOLTED CONNECTIONS**
**TYPE N&T**
**400/415 Volt Industrial Fuse-Links with Bolted Connections to BS88: Part 2 • IEC60269-2 • EN60269-2**

Rated voltages: 415V a.c., 250V d.c. Breaking range and utilization category: gG Rated breaking capacities: 80kA at 415V a.c, 40kA at 250V d.c.

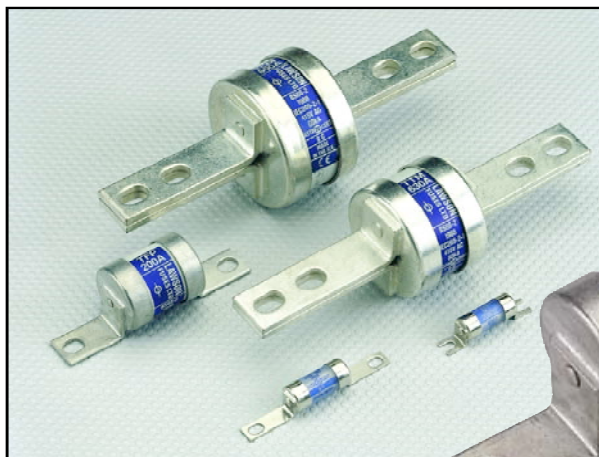

Lawson Type "N" & "T" fuse-links are for use in industrial installations and can be fitted into BS88 bolted fuse-holders and distribution fusegear. The range includes all BS88: Part 2 reference fuse-links up to 800 Amps and has gG classification, ensuring compliance with the current edition of the UK Wiring Regulations. Many non-reference tag variants are available to cater for installation in non-standard or specialised equipment.

The range has a rated voltage of 415V a.c. and has been certified at a test recovery voltage of at least 110%. These fuse-links are therefore suitable for use on systems with voltages up to 457V a.c. The range also has a rating of 250V d.c. A complementary range of solid/neutral links is available to suit our fuse-link range.

**Product Detail**
**Product detail - Offset Tag Fuse-Links**

List Reference	Current Rating (A)	BS88 Reference	Voltage Rating (V)	Breaking Capacity (kA)	BS Standard	IEC Standard	Carton Quantity	Carton Weight (Kg)
NIT	2,4,6,10,16,20,25,32	A1	415a.c. 240d.c.	80kA-a.c. 40kA-d.c.	BS88: Part 2	60269-2	10	0.13
GTIA	2,4,6,10,16,20,25,32	A2					10	0.20
TIA	2,4,6,10,16,20,25,32	A2					10	0.54
TIS	35,40,50,63,	A3					10	0.58
TIS	80,100,125	A3					10	0.70
TCP	6,10,16,20,25,32,	A4					5	0.46
TCP	40,50,63,80,100	A4					5	0.52
TFP	125,160,200	(as A4)					5	0.82
85TM	200,250,315,355,400	-					1	0.46
86 TT	450,500,560,630,	-					1	0.58
86 TT	670,710,750,800	-					1	0.70

**Product detail - Central Tag Fuse-Links**

List Reference	Current Rating (A)	BS88 Reference	Voltage Rating (V)	Breaking Capacity (kA)	BS Standard	IEC Standard	Carton Quantity	Carton Weight (Kg)
TB	2,4,6,10,16,20,25,	-	415a.c. 240d.c.	80kA-a.c. 40kA-d.c.	BS88: Part 2	60269-2	10	0.60
TB	32,35,40,50,63	-					10	0.60
TBC	2,4,6,10,16,20,25,	(as B1)					10	0.62
TBC	32,35,40,50,63	(as B1)					10	0.62
TC	80,100	B1					5	0.58
TF	125,160,200	B2					5	0.85
84TF	80,100,125,160,200	-					5	0.94
TKF	250,315	B3					1	0.23
84TK	250,315	-					1	0.23
TKM	125,160,200,250,315	-					1	0.28
TMF	315,355,400	B4					1	0.43
TM	250,315,355,400	C1					1	0.55
TMT	355,400	-					1	0.60
TTM	450,500,560,630	C2					1	0.74
TT	450,500,560,630	-					1	0.60
TLM	670,710,750,800	C3					1	1.00
TLT	670,710,750,800	-					1	1.30
TLU	450,500,560,630	D1					1	1.50
TLU	670,710,750,800	D1	1	1.50				

See pages 22 & 23 for the time/current and cut-off current characteristics.  
 See pages 10 & 11 for Motor Circuit Protection.



# INDUSTRIAL FUSE-LINKS WITH BOLTED CONNECTIONS

## TYPE N&T

### Dimensional Drawings

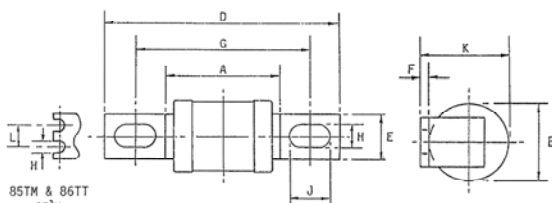

BS88: Part 2 reference 'A' fuse-link dimensions and tag variants

BS88 Ref.	Type Ref.	Current Ratings (A)	Dimensions (mm)										
			A max	B max	D max	E max	F nom	G nom	H nom	J nom	K max	L nom	
A1	NIT	2,4,6,10,16, 20,25*,32*	33	12.7	56	9.5	0.8	44.5	4.8	OPEN SLOT	14.3		
A2	GTIA	2,4,6,10,16, 20,25,32	34	14.3	86	9	1.2	73	5.5	8	16		
A2	TIA	2,4,6,10,16, 20,25,32	49	22	86	9	1.2	73	5.5	8	24		
A3	TIS	35*,40,50,63, 80*,100*,125*	49	22	89	13	1.2	73	5.5	OPEN SLOT	24		
A4	TCP	6,10,16,20,32,40,50,63, 80,100	51	22	110	20	2.4	94	8.7	11	25		
as A4	TFP	125,160,200	51	35	110	20	2.4	94	8.7	11	38		
-	85TM	200,250,315,355*,400	56	51	117	45	4.8	102	8.7	OPEN SLOT	45	22	
-	86TT	450*,500,560*,630, 670*,710*,750*,800	56	61	117	45	4.8	102	8.7	OPEN SLOT	54	22	
-			56	73	117	45	4.8	102	8.7	OPEN SLOT	61	22	

\* Non-Standardized current rating additional to BS88: Part 2

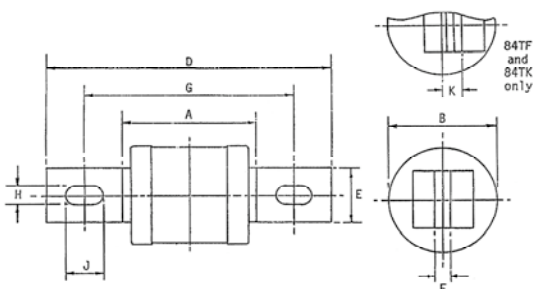

BS88: Part 2 reference 'B' fuse-link dimensions and tag variants

BS88 Ref.	Type Ref.	Current Ratings (A)	Dimensions (mm)										
			A max	B max	D max	E max	F nom	G nom	H nom	J nom	K max	L max	
-	TB	2,4,6,10,16,25,32,35*,40,50,63	45	22	111	13	1.2	97	7.1	13			
as B1	TBC	2,4,6,10,16,25,32,35*,40,50,63	45	22	137	15	1.4	111	8.7	14			
B1	TC	80,100	45	26	137	20	3.2	111	8.7	14			
B2	TF	125,160,200	45	35	137	20	3.2	111	8.7	14			
-	84TF	80,100,125,160,200	45	35	121	20	3.2	99	8.7	14	5		
B3	TKF	250,315	45	41	137	26	3.2	111	8.7	14			
-	84TK	250,315	45	41	121	26	3.2	99	8.7	14	8		
-	TKM	125,160,200,250,315	45	41	159	26	3.2	133	10.3	14			
B4	TMF	315,355*,400	52	51	137	26	6.4	111	8.7	16			

\* Non-Standardized current rating additional to BS88: Part 2

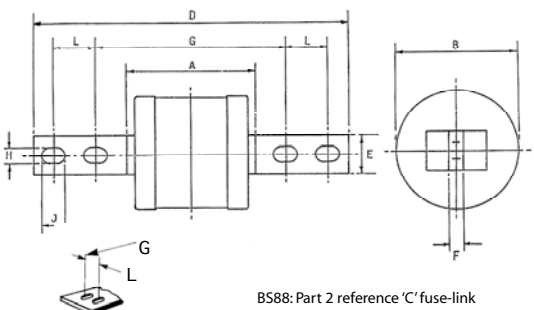

BS88: Part 2 reference 'C' fuse-link dimensions and tag variants

BS88 Ref.	Type Ref.	Current Ratings (A)	Dimensions (mm)										
			A max	B max	D max	E max	F nom	G nom	H nom	J nom	K max	L max	
C1	TM	250*,315*,355*,400	52	51	210	26	6.3	133	10.3	16	25.4		
-	TMT	355*,400	52	61	267	26	6.3	165	10.3	16	31.8		
C2	TTM	450*,500,560*,630	54	61	210	26	7.8	133	10.3	16	25.4		
-	TT	450*,500,560*,630	54	61	267	26	7.8	165	10.3	16	31.8		
C3	TLM	670*,710*,750*,800	56	73	210	26	9.5	133	10.3	16	25.4		
-	TLT	670*,710*,750*,800	56	73	267	26	9.5	165	10.3	16	31.8		
D1	TLU	450*,500,560*,630, 670*,710*,750*,800	56	73	267	26	9.5	149	10.3	16	31.8		

\* Non-Standardized current rating additional to BS88: Part 2

### Motor Circuit Protection Fuse-Links see pages 10 & 11

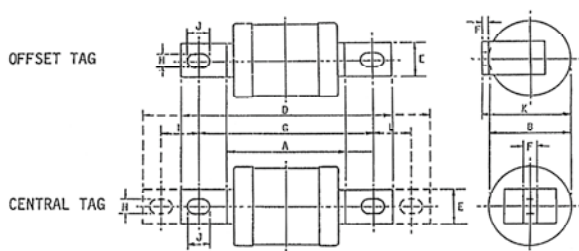

BS88 Ref.	Type Ref.	Current Ratings cont M motor (A) (A)	Dimensions (mm)										
			A max	B max	D max	E max	F nom	G nom	H nom	J nom	K max	L nom	
Offset Tag													
A1	NIT	20M25,32	33	12.7	56	9.5	0.8	44.5	4.8	OPEN SLOT	14.3		
A2	TIA	32M40,50,63	49	22	86	9	1.2	73	5.5	8	24		
A3	TIS	63M80,100M125	49	26	89	13	1.2	73	5.5	OPEN SLOT	28		
A4	TCP	100M125,160,200	51	35	110	20	2.4	94	8.7	11	38		
as A4	TFP	200M250,315	51	41	110	20	2.4	94	8.7	11	45		
Central Tag (single hole)													
-	TB	63M80,100	45	26	111	13	1.2	97	7.1	13	-		
as B1	TBC	63M80,100	45	26	137	20	3.2	111	8.7	14	-		
B1	TC	100M125,160,200	45	35	137	20	3.2	111	8.7	14	-		
B2	TF	200M250,315	45	41	137	20	3.2	111	8.7	14	-		
B3	TKF	315M400*	45	51	137	26	6.4	111	8.7	14	-		
B4	TMF	400M500*	52	61	137	26	6.4	111	8.7	16	-		
Central Tag (double hole)													
C1	TM	400M500*	51	61	210	26	6.4	133	10.3	16	-	25.4	

\* Non-Standardized current rating additional to BS88: Part 2

NOTE: Cont= Continuous Current. Motor = Motor Starting Current



**INDUSTRIAL FUSE-LINKS WITH BOLTED CONNECTIONS**
**TYPE SS**
**660/690 Volt Industrial Fuse-Links with Bolted Connections to BS88: Part 2 • IEC60269-2 • EN60269-2**

Rated voltages: 660V a.c., 250V d.c. Breaking range and utilization category: gG Rated breaking capacities: 80kA at 660V a.c., 40kA at 250V d.c.

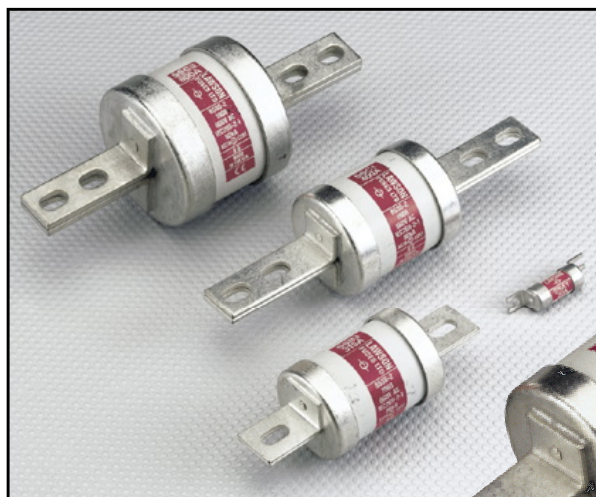

Lawson Type "SS" fuse-links are for use in industrial applications and have been approved by leading authorities including Electricity Supply Authorities. The range includes all BS88: Part 2 reference fuse-links up to 800 Amps and has gG classification. Non-reference tag variants cater for installation in non-standard or specialised equipment.

The range has a rated voltage of 660V a.c., and has been certified at a test recovery voltage of at least 110%. These fuse-links are therefore suitable on systems that meet the nominal harmonised voltage of 690V a.c., + 5%. The range also has a rating of 250V d.c.

A complementary range of solid/neutral links is available to suit our fuse-link range.

**Product Detail**
**Product detail - Offset Tag Fuse-Links**

List Reference	Current Rating (A)	BS88 Reference	Voltage Rating (V)	Breaking Capacity (kA)	BS Standard	IEC Standard	Carton Quantity	Carton Weight (Kg)
SSA1	2,4,6,10,16,20	A1	660a.c. 250d.c.	80kA-a.c. 40kA-d.c.	BS88: Part 2	60269-2	10	0.15
SSA2	2,4,6,10,16,20,25,32	A2					10	0.50
SSA3	35,40,50,63	A3					10	0.80
SSA4	32,40,50,63,80,100	A4					5	0.90
SSFP	125,160,200	(asA4)					1	0.25
85SSM	355,400	-					1	1.05
86SST	450,500,560,630,	-					1	1.40
86SST	670,710,750,800	-					1	1.40

**Product detail - Central Tag Fuse-Links**

List Reference	Current Rating (A)	BS88 Reference	Voltage Rating (V)	Breaking Capacity (kA)	BS Standard	IEC Standard	Carton Quantity	Carton Weight Kg
SSB	2,4,6,10,16,20,25,	-	660a.c. 250d.c.	80kA-a.c. 40kA-d.c.	BS88: Part 2	60269-2	10	0.60
SSB	32,35,40,50,63	-					10	0.75
SSBC	2,4,6,10,16,20,25,	(as B1)					10	0.60
SSBC	32,35,40,50,63	(as B1)					10	0.75
SSB1	80,100	B1					5	0.90
SSB2	125,160,200	B2					1	0.25
84SSF	125,160,200	-					1	0.25
SSB3	250,315	B3					1	0.45
84SSK	250,315	-					1	0.45
SSKM	125,160,200,250,315	-					1	0.45
SSB4	355,400	B4	1	0.65				
SSC1	355,400	C1	1	0.78				
SSMT	355,400	-	1	0.83				
SSC2	450,500,560,630	C2	1	1.05				
SST	450,500,560,630	-	1	1.05				
SSC3	670,710,750,800	C3	1	1.40				
SSLT	670,710,750,800	-	1	1.40				
SSLU	450,500,560,630,	D1	1	2.40				
SSLU	670,710,750,800	D1	1	2.40				

See page 24 for the time/current and cut-off current characteristics.

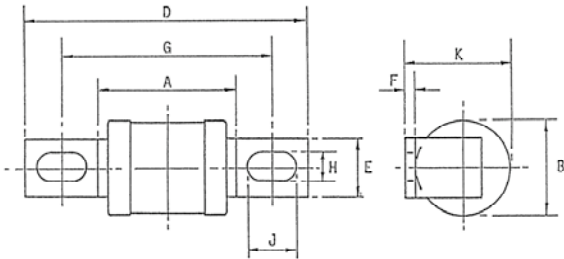

**INDUSTRIAL FUSE-LINKS WITH BOLTED CONNECTIONS**
**TYPE SS**
**Dimensional Drawings**

BS88: Part 2 reference 'A' fuse-link dimensions and tag variants

BS88 Ref.	Type Ref.	Current Ratings (A)	Dimensions (mm)									
			A max	B max	D max	E max	F nom	G nom	H nom	J nom	K max	
A1	SSA1	2,4,6,10,16,20	34	14.3	56	9.5	1.2	44.5	4.8	OPEN	14.3	
A2	SSA2	2,4,6,10,16,20,25,32	49	22	86	9	1.2	73	5.5	8	24	
A3	SSA3	35*,40,50,63	53	26	89	13	1.2	73	5.5	OPEN	28	
A4	SSA4	32,40,50,63	51	26	110	20	2.4	94	8.7	11	25	
A4	SSA4	80,100	60	35	110	20	2.4	94	8.7	11	38	
as A4	SSFP	125,160,200	60	41	110	20	2.4	94	8.7	11	42	
-	85SSM	355,400	60	61	110	20	2.4	102	8.7	11	42	
-	86SST	450*,500,560*,630	60	73	110	20	2.4	102	8.7	11	42	
-		670*,710*,750*,800	60	83	110	20	2.4	102	8.7	11	42	

\* Non-Standardized current rating additional to BS88: Part 2

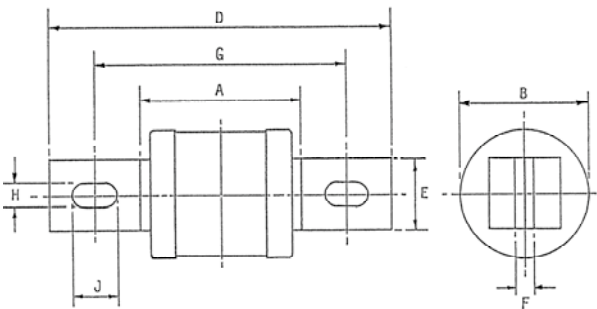

BS88: Part 2 reference 'B' fuse-link dimensions and tag variants

BS88 Ref.	Type Ref.	Current Ratings (A)	Dimensions (mm)									
			A max	B max	D max	E max	F nom	G nom	H nom	J nom		
-	SSB	2,4,6,10,16,20,25,32	45	22	111	13	1.2	97	7.1	13		
-		35*,40,50,63	53	26	111	13	1.2	97	7.1	13		
as B1	SSBC	2,4,6,10,16,20,25,32	45	22	137	15	1.4	111	8.7	14		
-		35*,40,50,63	53	26	137	15	1.4	111	8.7	14		
B1	SSB1	80,100	60	35	137	20	3.2	111	8.7	14		
B2	SSB2	125,160,200	60	41	137	20	3.2	111	8.7	14		
-	84SSF	125,160,200	60	41	137	20	3.2	111	8.7	14		
B3	SSB3	250,315	75	51	137	26	3.2	111	8.7	14		
-	84SSK	250,315	60	51	137	20	3.2	111	8.7	14		
-	SSKM	125,160,200,250,315	75	51	159	26	3.2	133	10.3	14		
B4	SSB4	355*,400	77	61	137	26	6.4	111	8.7	16		

\* Non-Standardized current rating additional to BS88: Part 2

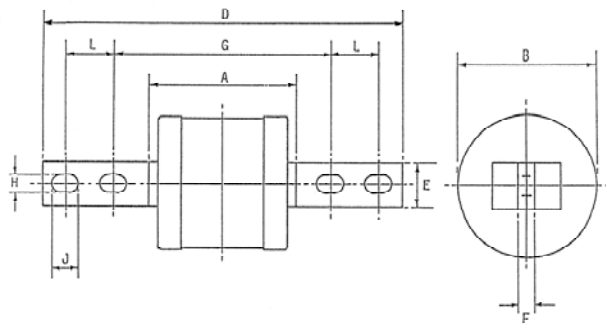

BS88: Part 2 reference 'C' fuse-link dimensions and tag variants

BS88 Ref.	Type Ref.	Current Ratings (A)	Dimensions (mm)									
			A max	B max	D max	E max	F nom	G nom	H nom	J nom	L max	
C1	SSC1	355*,400	77	61	210	26	6.3	133	10.3	16	25.4	
-	SSMT	355*,400	77	61	267	26	6.3	165	10.3	16	31.8	
C2	SSC2	450*,500,560*,630	80	73	210	26	7.8	133	10.3	16	25.4	
-	SST	450*,500,560*,630	80	73	267	26	7.8	165	10.3	16	31.8	
C3	SSC3	670*,710*,750*,800	83	83	210	26	9.5	133	10.3	16	25.4	
-	SSLT	670*,710*,750*,800	83	83	267	26	9.5	165	10.3	16	31.8	
D1	SSLU	450*,500,560*,630	83	73	267	26	9.5	149	10.3	16	31.8	
		670*,710*,750*,800	83	83	267	26	9.5	149	10.3	16	31.8	

\* Non-Standardized current rating additional to BS88: Part 2



Parallel tag fixings on SSLU only

## COMPACT DIMENSION FUSE-LINKS

## TYPE CDS

### 230/240 Volt and 400/415 Volt Compact Dimension Fuse-Links to BS88: Part 6 • IEC60269-2

Rated voltages: 240V a.c. and 415V a.c. Breaking range and utilisation category: gG Rated breaking capacities: 20kA at 240V a.c. and 80kA at 415V a.c.



Compact Type "CDS" fuse-links are for use in single or three phase commercial and industrial installations and can be fitted into BS88 bladed type fuse-holders and distribution fusegear.

The Lawson CLIPFIT range has rated voltages of 240V a.c. or 415V a.c. and has been certified at a test recovery voltage of at least 110%. These fuse-links therefore are suitable for use on systems with voltages up to 264 or 457V a.c. The rated and test voltages also ensure that the range meets all the transitional voltage requirements specified within the harmonised nominal voltages of 230/400V a.c. A complementary range of solid/neutral links is available to suit our fuse-link range.

#### Product and Performance Data - Compact Dimension Fuse-Links

List Reference	Current Rating (A)	BS88 Reference	Voltage Rating (V)	Breaking Capacity (kA)	BS Standard	IEC Standard	Carton Quantity	Carton Weight (Kg)
SS	2,4,6,10,16,20,25,32	E1	240a.c.	20kA-a.c.	BS88: Part 6	60269-2	10	0.12
NS	2,4,6,10,16,20,25,32	F1	415a.c.	80kA-a.c.			10	0.18
MES	10,16,20,25,32,40,50,63	F2	415a.c.	80kA-a.c.			10	0.32

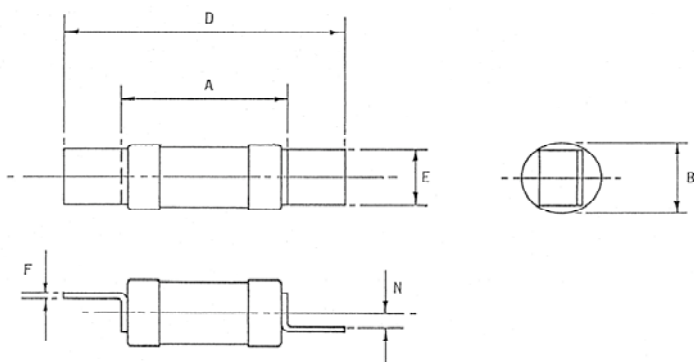

#### Dimensions

BS88 Ref.	Type Ref.	Rated Voltage (V a.c.)	Current Ratings (A)	Dimensions (mm)					
				A max	B max	D max	E nom	F nom	N nom
E1	SS	240	2,4,6,10,16,20,25*,32*	25	12.7	51	11.5	0.8	3.5
F1	NS	415	2,4,6,10,16,20,25*,32*,20M25*,20M32*	35.5	14.3	62	11.5	0.8	3.5
			32M40*,32M50*,32M63*	39	17.5	62	11.5	0.8	3.5
F2	MES	415	10,16,20,25,32,40,50,63	39	17.5	69	15	1.4	3.5

\* Non-Standardized current rating additional to BS 88: Part 6



See pages 10 & 11 for Motor Circuit Protection.  
See page 25 for the time/current and cut-off current characteristics.

**STREET LIGHTING CUT-OUT FUSE-LINKS**
**TYPE LST**
**230/240 Volt Street Lighting Cut-Out Fuse-Links to BS88: Part 1 • IEC60269-1**

Rated voltage: 240V a.c. Breaking range and utilization category: gG Rated breaking capacity: 20kA at 240V a.c.

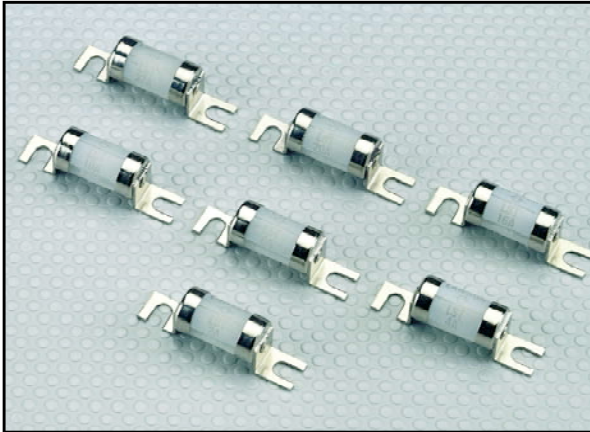

Lawson Type "LST" fuse-links are for use in single-phase street lighting cut-outs or similar installations. These fuse-links comply with UK Electricity Supply Industry Standards and BS7654.

Leading authorities, including Lloyds Register of Shipping and Electricity Supply Authorities, have approved fuse-links within this range.

A complementary range of solid/neutral links is available to suit our fuse-link range.

**Current ratings and fixing centre**

Current Rating (A)	List Reference	Fixing Centre (mm)	Carton Quantity	Carton Weight (Kg)
2	LST2	38.5	10	0.12
4	LST4			
6	LST6			
10	LST10			
16	LST16			
20	LST20			
25	LST25			
32	LST32			

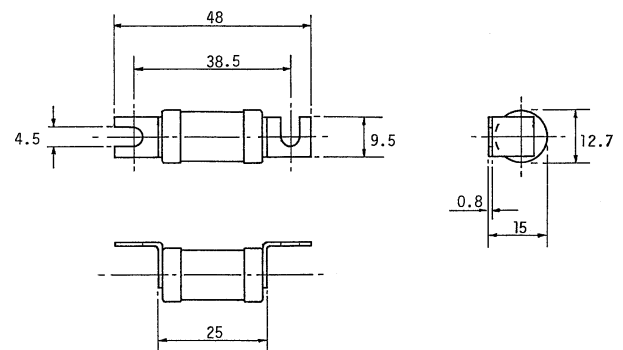

Dimensions = mm







## PRODUCT DETAIL AND PERFORMANCE DATA

### Product detail - Dual Rated Fuse-Links - Offset Tag

List Reference	Current Rating (A)	BS88 Reference	Voltage Rating (V)	Breaking Capacity (kA)	BS Standard	IEC Standard	Carton Quantity	Carton Weight (Kg)
NIT	20M25,20M32	A1	415a.c.	80kA-a.c.	BS88: Part 2	60269-2	10	0.13
TIA	32M40,32M50,32M63	A2					10	0.54
TIS	63M80,63M100,100M125	A3					10	0.70
TCP	100M125,100M160	A4					5	0.82
TCP	100M200	A4					5	0.82
TFP	200M250,200M315	(as A4)					1	0.24

### Product detail - Dual Rated Fuse-Links - Central Tag

List Reference	Current Rating (A)	BS88 Reference	Voltage Rating (V)	Breaking Capacity (kA)	BS Standard	IEC Standard	Carton Quantity	Carton Weight (Kg)
TB	63M80,63M100	-	415a.c.	80kA-a.c.	BS88: Part 2	60269-2	10	0.72
TBC	63M80,63M100	(as B1)					10	0.72
TC	100M125,100M160	B1					5	0.85
TC	100M200	B1					5	0.85
TF	200M250,200M315	B2					1	0.24
TKF	315M400	B3					1	0.43
TMF	400M500	B4					1	0.55
TM	400M500	C1	1	0.74				

### Product detail - Dual Rated Fuse-Links - Compact Dimension

List Reference	Current Rating (A)	BS88 Reference	Voltage Rating (V)	Breaking Capacity (kA)	BS Standard	IEC Standard	Carton Quantity	Carton Weight (Kg)
NS	20M25, 20M32	F1	415a.c.	80kA-a.c.	BS88: Part 6	60269-2	10	0.18
NS	32M40,32M50,32M63	-					10	0.32

### Performance Data - Dual Rated Fuse-Links - Offset Tag

List Reference	Current Rating (A)		BS88 Reference	Utilization Category
	Cont	Motor		
NIT	20	25	A1	gM
NIT	20	32	A1	
TIA	32	40	A2	
TIA	32	50	A2	
TIA	32	63	A2	
TIS	63	80	A3	
TIS	63	100	A3	
TIS	100	125	A3	
TCP	100	125	A4	
TCP	100	160	A4	
TCP	100	200	A4	
TFP	200	250	(as A4)	
TFP	200	315	(as A4)	

### Performance Data - Dual Rated Fuse-Links - Central Tag

List Reference	Current Rating (A)		BS88 Reference	Utilization Category
	Cont	Motor		
TB	63	80	-	gM
TB	63	100	-	
TBC	63	80	(asB1)	
TBC	63	100	(asB1)	
TC	100	125	B1	
TC	100	160	B1	
TC	100	200	B1	
TF	200	250	B2	
TF	200	315	B2	
TKF	315	400	B3	
TMF	400	500	B4	
TM	400	500	C1	

### Performance Data - Dual Rated Fuse-Links - Compact Dimension

List Reference	Current Rating (A)		BS88 Reference	Utilization Category
	Cont	Motor		
NS	20	25	F1	gM
NS	20	32	F1	
NS	32	40	-	
NS	32	50	-	
NS	32	63	-	

NOTE: Cont= Continuous Current. Motor = Motor Starting Current

See pages 22,23 & 25 for the time/current and cut-off current characteristics.





**INDUSTRIAL FUSE-LINKS WITH KNIFE BLADE CONTACTS**

**LSPN**

**500 Volt NH-System Fuse-Links with Knife Blade Contacts to IEC60269-2**

Rated voltage: 500V a.c. Breaking range and utilization category: gG Rated breaking capacity: 120kA at 500V a.c.



**Current ratings and principal dimensions**

Size	Type Reference	Current Rating (A)	Dimensions (mm)						
			a1	a2	a3	a4	b	e1	e2
000	LSPN	6 10 16 20 25 32 40 50 63	78,5	54	45	49	15	39	29
00	LSPN	10 16 20 25 32 40 50 63 80 100	78,5	54	45	49	15	38	29
		125 160						45	29
0	LSPN	32 40 50 63 80 100	125	68	62	68	15	38	29
		125 160						45	29
1	LSPN	32 40 50 63 80 100 125 160	135	75	62	68	20	45	29
		200 250						50	44
2	LSPN	40 50 63 80 100 125 160 200 250	150	75	62	68	25	50	44
		315 250 400						58	50
3	LSPN	315 400 500 630	150	75	62	68	32	73	71

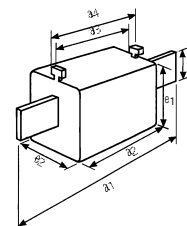

**Also available.**

1. Ranges of Fuse-Links for motor circuit and semi conductor protection are also available
2. A range of Fuse-Bases and accessories are also available.

**D FUSE-LINKS**

**TYPE LD**

**500 Volt Diazed Fuse-Links to IEC60241 • IEC60269-3 • DIN-VDE 0636 Part 31**

Rated voltages: 500V a.c. Breaking range and utilization category: gG Rated breaking capacities: 50kA a.c.



**Current ratings and principal dimensions**

List References		Current Rating (A)	Principal Dimensions	
Slow Acting	Quick Acting		Length mm	Diameter mm
LD12	LD12Q	2 4 6 10 16 20 25	50	12
LD22	LD22Q	2 4 6 10 16 20 25	50	22
LD27	LD27Q	35 40 63	50	27
LD37	LD37Q	80 100	63	37
LD51	-	125 160 200	66	51

**Also available.**

1. Ranges of Fuse-Links for motor circuit and semi conductor protection are also available
2. A range of Fuse-Bases and accessories are also available.

**DO FUSE-LINKS**

**TYPE LNZ**

**400 Volt Neozed Fuse-Links to IEC60269-3 • DIN-VDE 0636 Part 41**

Rated voltages: 400V a.c., 250V d.c. Breaking range and utilization category: gG Rated breaking capacities: 50kA a.c., 8kA d.c.



**Also available.**

1. Ranges of Fuse-Links for motor circuit and semi conductor protection are also available
2. A range of Fuse-Bases and accessories are also available.

**Current ratings and principal dimensions**

List References		Current Rating (A)	Principal Dimensions	
400V a.c.			Length mm	Diameter mm
LNZ11-400		2 4 6 10 16	36	11
LNZ15-400		20 25 35 50 63	36	15
LNZ22-400		80	43	22

**ADDITIONAL FUSE-LINK TYPE** **TYPE PO**

**Fuse-Links for System X to British Telecom Specification PT 1360**

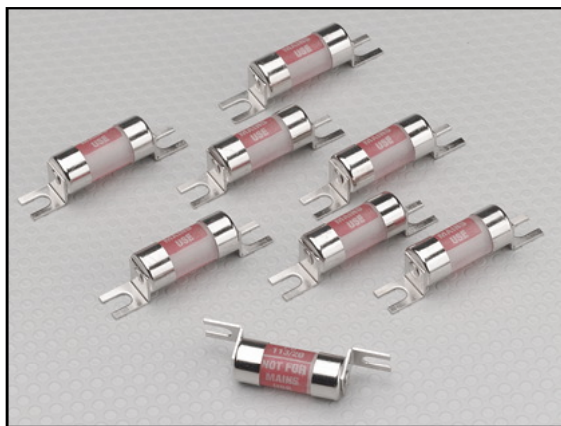

List Reference	PO 113/20
Rated Current	20A
Rated Voltage	50V d.c.
Rated Breaking Capacity	5000A @ 50V d.c. (5mstc)
Power Dissipation	1.8w @ 20A
Max Cut Off Current	940A @ 5000A prospective
Max Arc Voltage	160V
Min prearc I <sup>2</sup> t	420 amp <sup>2</sup> sec
Max prearc I <sup>2</sup> t	650 amp <sup>2</sup> sec
Min arcing time	0.6ms
Time/Current Characteristics	20A Zone to BS88: Part 2

British Telecom Certificate Number 0460

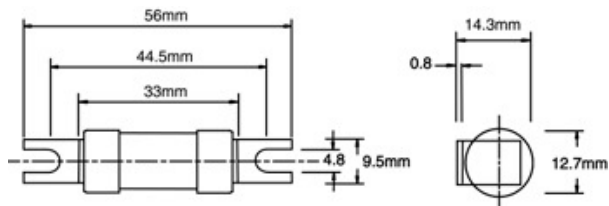

**ADDITIONAL FUSE-LINK TYPE** **TYPE ABB**

**400/415 Volt British Standard fuse-links for incorporation in ABB slim line compact fuse-switches**

Rated voltage: 415V a.c. Breaking range and utilization category: gG Rated breaking capacity: 80kA at 415V a.c.



List Reference	Current Rating (A)	EQ DIN/NH
00T	10,16,20,25,32,40,50,63,80,100,125,160	00
3T	450,500,560,630	3

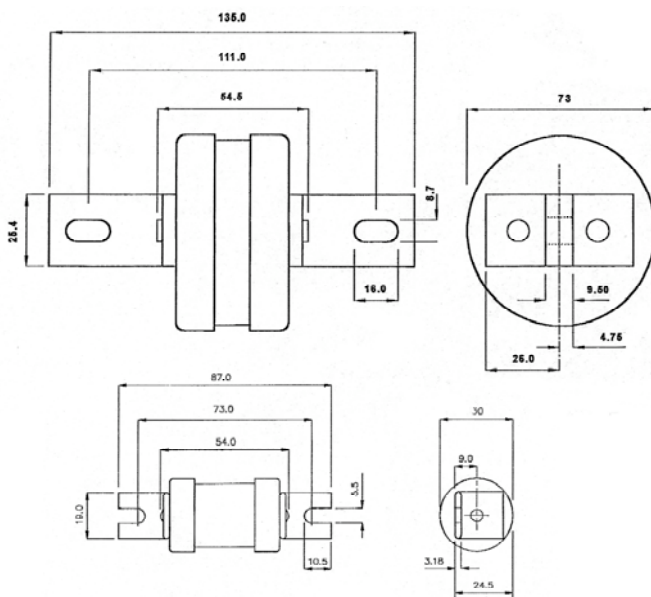

See pages 22 & 23 for the time/current and cut-off current characteristics.



**ELECTRICITY SUPPLY FUSE-LINKS**
**TYPE J**
**400/415 Volt Electricity Supply Distribution Fuse-Links to BS88: Part 5 • IEC60269-2 Pending**

Rated voltage: 415V a.c. Rated breaking capacity: 80kA at 415V a.c.



The range has a rated voltage of 415V a.c. and has been certified at a test recovery voltage of 110%. These fuse-links are therefore suitable for use on systems with voltages up to 457V a.c. The rated and test voltages also ensure that the range meet all the transitional voltage requirements specified within the harmonised nominal voltage of 400V a.c.

Lawson Type "J" fuse-links are for use in a.c. electricity supply networks. They are installed in distribution boards, feeder pillars, link boxes, pole mounted cut-outs and heavy duty service intakes. The range includes all the current ratings specified in BS88: Part 5 for fuse-links with the standard 82mm and 92mm fixing centres, together with additional non-specified current ratings. A similar range of fuse-links with non-standard 76mm fixing centres is available in ratings up to 315 Amps. In addition, a range of cylindrical fuse-links up to 315 Amps, with the same characteristics as the tagged pattern, is available for installation in pole mounted cut-outs.

**Performance Data and Product Detail**
**Performance Data - Electricity Supply Fuse-Links**

List Reference	Current Rating (A)	Voltage Rating (V)	Breaking Capacity (kA)	BS Standard	IEC Standard	Carton Quantity
JPU	20,32,40,50,63,80,100,125	415a.c.	80kA a.c.	BS88: Part 5	60269-2 (Pending)	5
JPU	160,200,250					5
JPU	315,355,400					5
JPU	450,500,560,630					1
JSU	20,32,40,50,63					5
JSU	80,100,125,160,200					5
JSU	250,315,355,400					5
JSU	450,500,560,630					1
JSU	800					1
JHU	20,32,40,50,63					5
JHU	80,100,125,160					5
JHU	200,250,315					5
JF	20,32,40,50,63,80					5
JF	100,125,160,200					5
JF	250,315					5

See page 26 for the time / current and cut-off current characteristics.



**ELECTRICITY SUPPLY FUSE-LINKS** **TYPE J**

**Principal Dimensions**

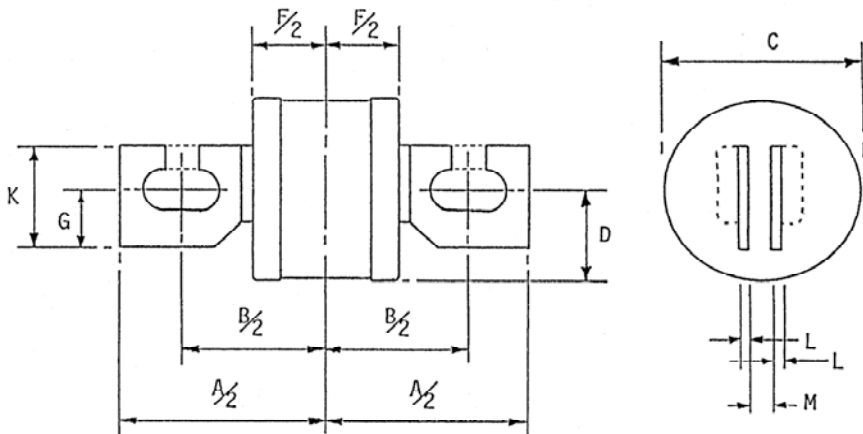

**Notes:**  
JPU 450,500,560 and 630A ratings are restricted to intermittent loading when installed in 400A fixed contacts.

JSU 800A rating is restricted to intermittent loading when installed in 630A fixed contacts.

BS88: Part 5 specifies performance requirements for ratings only up to and including 630A, therefore the performance characteristics of JSU 800 Amp rating comply with BS88: Part 2.

Non slotted tag variant fuse-links are available, details on request.

BS88 Ref.	Type Ref.	Current Ratings (A)	Dimensions (mm)									
			A	B	C	D	F	G	K	L	M	
			max	nom	max	max	max	nom	max	nom	max/min	
<b>STANDARDIZED DIMENSIONS</b>												
	JPU	20*,32*,40*,50*,63*,80,100,125*	112	82	26	14	45	18	31	2.4	6.53 6.45	
	JPU	160	112	82	31	16	45	18	31	2.4		
	JPU	200,250	112	82	35	18	45	18	31	2.4		
	JPU	315,355,400	112	82	41	18	45	18	31	2.4		
	JPU	450*,500*	112	82	51	18	45	18	31	2.4		
	JPU	560*,630*	112	82	61	21	45	18	31	2.4		
	JSU	20*,32*,40*,50*,63*,80,100,125*,160	132	92	31	16	45	22	38	3.2	8.13 8.05	
	JSU	200,250	132	92	35	17	45	22	38	3.2		
	JSU	315,355,400	132	92	41	20	45	22	38	3.2		
	JSU	450*500	132	92	51	20	45	22	38	3.2		
	JSU	560*630	132	92	61	25	45	22	38	3.2		
	JSU	800*	132	92	73	25	45	22	38	3.2		
<b>NON-STANDARDIZED DIMENSIONS</b>												
	JHU	20*,32*,40*,50*,63*,80*,100,125*,160	100	76	31	11	45	18	31	1.6	4.25	
	JHU	200,250	100	76	35	13	45	18	31	1.6	4.17	
	JHU	315	100	76	41	12	45	18	31	1.6		

\* Non-Standardized current rating additional to BS88: Part 5

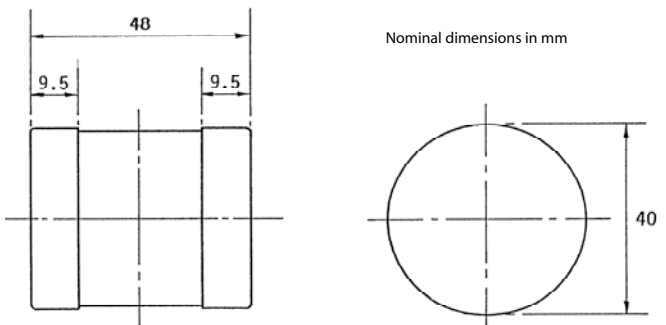

Type Ref	Current Ratings (A)
JF	20*,32*,40*,50*,63*,80*,100,125*,160,200,250,315

\* Non-Standardized current rating additional to BS88: Part 5



## HOUSE SERVICE CUT-OUT FUSE-LINKS

## TYPE ME &amp; MF

## 400/415 Volt House Service Cut-Out Fuse-Links to BS1361 • IEC60269-3

Rated voltage: 415V a.c. Fusing factor: not exceeding 1.5 (Class Q1) Rated breaking capacity: 33kA at 0.3 p.f. (tested at 80 kA at 0.15 p.f.)



Lawson Type "ME" and "MF" fuse-links are for use in single or three-phase house service cut-outs or similar installations. The standardized BS 1361 breaking capacity of these fuse-links is 33kA at 0.3p.f. However to cater for increasing fault levels all Lawson house service cut-out fuse-links have been ASTA tested to 80kA at 0.15 p.f.

## Current ratings and list references

BS1361 Type	Current Rating (A)	List Reference	Carton Quantity	Carton Weight (Kg)
II <sub>a</sub>	5 (6)	ME5 (6)	10	0.55
	10	ME10		
	15 (16)	ME15 (16)		
	20	ME20		
	25	ME25		
	30 (32)	ME30 (32)		
	40	ME40		
	45	ME45		
	50	ME50		
	60 (63)	ME60 (63)		
	80	ME80		
100*	ME100			
II <sub>b</sub>	20	MF20	10	1.06
	30 (32)	MF30 (32)		
	40	MF40		
	45	MF45		
	50	MF50		
	60(63)	MF60 (63)		
	80	MF80		
	100	MF100		

\*ME100 harmonised current rating in accordance with IEC 60269-3

( ) Current rating in accordance with IEC 60269-3 & future BS88: Part 3

## Dimensional Drawings

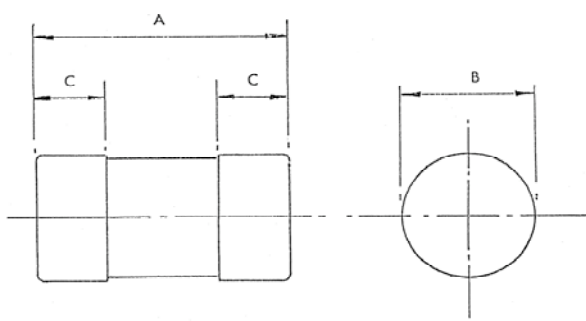

Type Reference	Dimensions (mm)		
	A	B	C
ME	57	22.23	16
MF	57	30.16	16

## Note:

These fuse-links comply with the requirements of IEC 60269-3 which forms the basis of the future BS88: Part 3, superseding the present BS 1361.



See page 27 for the time/current and cut-off current characteristics.



## CONSUMER UNIT FUSE-LINKS

## TYPE L

### 230/240 Volt Consumer Unit Fuse-Links to BS1361

Rated voltage: 240V a.c. Fusing factor: not exceeding 1.5 (Class Q1) Rated breaking capacity: 16.5kA at 240V a.c.



Lawson Type "L" fuse-links are for use in household consumer units or other single-phase installations with fault levels up to 16kA. These fuse-links comply with BS1361 for Type 1 fuse-links and are covered by ASTA Certificates of Short Circuit Rating.

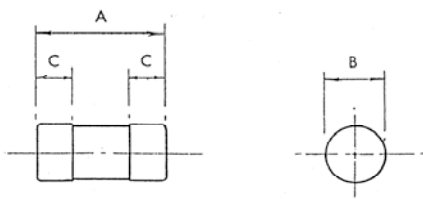

TYPE REF.	DIMENSIONS (mm)		
	A	B	C
LA	23	6.35	4.8
LC	26	10.32	6.4
LD	29	12.7	8.0
LK	35	16.67	9.5

#### Current ratings and principal dimensions

BS 1361 Type	Current Rating (A)		List Reference	Colour Coding	Carton Quantity	Carton Weight (Kg)
	BS1361	BS88				
I	-	2	LA2	BLACK	100	0.20
	5	-	LA5	WHITE*		
	-	2	LC2	BLACK	100	0.60
	-	5	LC5	BLACK		
	-	8	LC8	BLACK		
	-	10	LC10	BLACK		
	15	-	LC15	BLUE*		
	20	-	LC20	YELLOW*		
	-	6	LD6	BLACK	100	1.00
	-	10	LD10	BLACK		
	-	16	LD16	BLACK		
	-	20	LD20	BLACK		
	-	25	LD25	BLACK		
	30	-	LD30	RED*		
-	35	LK35	BLACK	10	0.20	
-	40	LK40	ORANGE			
45	-	LK45	GREEN*			

\* BS1361 Colour Coding

**Note:** In addition to the current ratings specified in BS1361, other non-standard current ratings, certified to various editions of BS88, have been introduced to meet requirements which have arisen over the years.

## PLUG TOP FUSE-LINKS

## TYPE PL

### 230/240 Volt Plug Top Fuse-Links to BS1362 and IEC60269-3

Rated voltage: 240V a.c. Rated breaking capacity: 6kA at 240V a.c.



Lawson Type "PL" fuse-links are intended primarily for use in domestic plugs but may also be installed in appropriate single-phase installations with fault levels up to 6kA and have nominal dimensions of 6.3 x 25.4mm.

#### Current ratings and principal dimensions

Current Rating (A)		List Reference	Colour Coding	Carton Quantity	Carton Weight (Kg)
Preferred	Other				
3	-	PL3	RED* -	100 (10X10)	0.26
-	5	PL5	- BLACK		
-	10	PL10	- BLACK		
13	-	PL13	BROWN* -		

\* BS1362 Colour Coding

PL 1,2, and 7 are also available, details on request



## ARTIC AND REYROLLE PATTERN

## TYPES A &amp; LGP

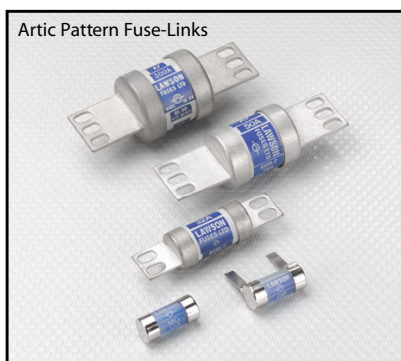

Lawson Type "A" fuse-links were originally developed and branded for the ARTIC Fuse Company. They were specifically designed for use only in ARTIC fuse-holders or fusegear and are still available from Lawson Fuses.

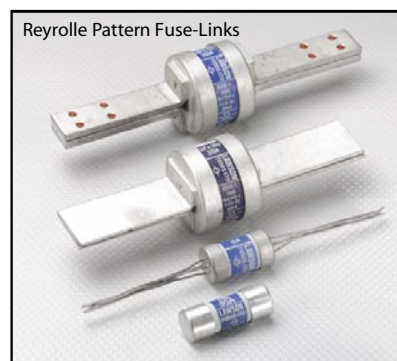

Lawson Type "LGP" fuse-links are for use in REYROLLE pattern Type 2 and Type 20 fuse-holders.

The LGP-2 fuse-link range has bolted tag connections except for the LGPF-2F which is fitted with wire tails.

The LGP-20 fuse-link range has plain tag connections except for Type LGPE-20E now replaced by the Lawson 'ME' range.

## Performance Data and Product Detail

## Artic Pattern Fuse-Links

List Reference	Current Rating (A)	Voltage Rating (V)	Breaking Capacity (kA)	BS Standard	IEC Standard	Carton Quantity
LO	2,5,5,10,16	240 a.c.	16kA			20
MO	2,4,6,10,16,20,25,32					20
OP	2,4,6,10,16,20,25,32					10
A5	10,16,20,25,32,40					10
A5	50,63,63M80,63M100					10
A7	40,50,63,80,100,125					5
A7	160,200,250,315	415 a.c.	80 kA a.c.	BS88: Part 1	60269-1	5
A8	125,160,200,250					1
A8	315,355,400,500					1
A8	630,710					1
A10	80,100,125,160,200					1
A11	355,400,500,630					1

## Reyrolle Pattern Fuse-Links

List Reference	Current Rating (A)	Voltage Rating (V)	Breaking Capacity (kA)	BS Standard	IEC Standard	Carton Quantity
LGPF-2F	6,10,16,20,32,40,50,63					5
LGPF-2F	80,100					5
LGPG-2G	160,200					1
LGPH-2H	160,200,250,315					1
LGPJ-2H	355,400					1
LGPJ-2J	500,630					1
LGPF-20F	16,32,40,50,63,80,100	415 a.c.	80 kA a.c.	BS88: Part 1	60269-1	5
LGPG-20G	125,160,200					1
LGPH-20H	125,160,200,250					1
LGPH-20H	315,355,400					1
LPGJ-20J	250,315,355,400					1
LPGJ-20J	500,630					1
LGPE-20E	5-100 (table on page 16)			BS 1361 Type 11a	60269-3	10

## ARTIC AND REYROLLE PATTERN

## TYPES A &amp; LGP

## Dimensional Drawings Type LGP

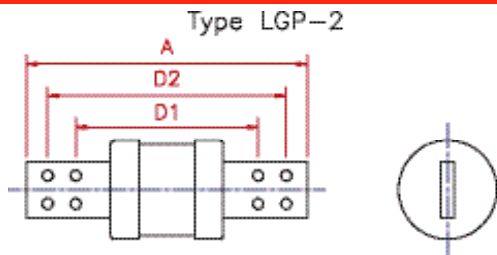

REYROLLE REFERENCE	LAWSON REFERENCE	CURRENT RATING	DIMENSIONS (mm)		
			A	D1	D2
GPE-2B GPE-2E GPE-2F	LGPF-2F	6	210	Fitted with flexible wire base 1.8mm dia.	
		10			
		16			
		20			
		32			
		40			
GPG-2G	LGPG-2G	50	206	144	186
		63			
		80			
		100			
		160			
		200			
GPH-2H	LGPH-2H	250	230	158	207
		315			
		355			
		400			
		500			
		630			
GPJ-2J	LGPJ-2J	500	260	162	228
		630			

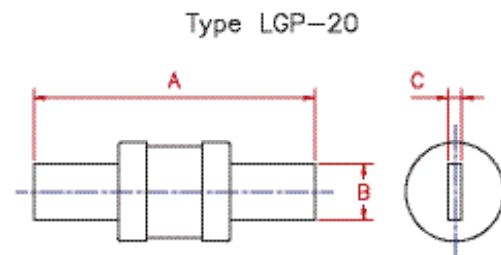

REYROLLE REFERENCE	LAWSON REFERENCE	CURRENT RATING	DIMENSIONS (mm)		
			A	B	C
GPE-20E	ME	16 32 40 50 6.3 80 100	128	20	3.2
GPE-20F GPF-20F	LGPF-20F				
GPG-20G	LGPG-20G	125 160 200	138	26	3.2
GPH-20H GPH-20H	LGPH-20H	125 160 200 250 315 355 400 480	168	26	6.4
GPH-20J GPJ-20J	LGPJ-20J	250 315 355 400 500 630	213	30	6.4

## Dimensional Drawings Type A

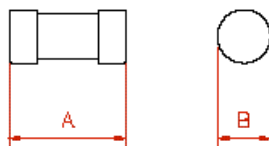

LAWSON REFERENCE	DIMENSIONS (mm)	
	A	B
LO	26	8
MO	32	14.5

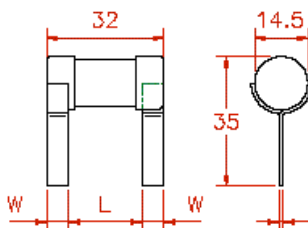

LAWSON REFERENCE	DIMENSIONS (mm)	
	L	W
OP 2-10A	20.5	6
OP 16-20A	17	7.5
OP 25-32A	14	9

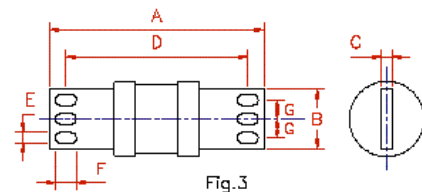
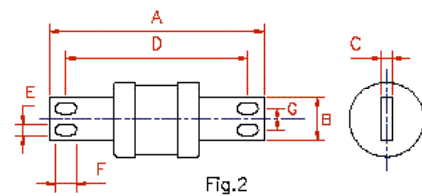
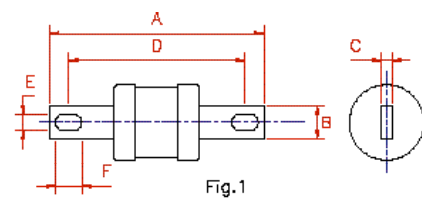

LAWSON REFERENCE	FIG. No.	DIMENSIONS (mm)						
		A	B	C	D	E	F	G
A5	2	88	20	1.6	71	5.5	10	9.5
A7	3	111	29	2.4	95	5.5	10	9.5
A8	3	127	42	6.3	106	7.1	13	11.9
A10	1	115	20	2.4	94	6.7	16	-
A11	1	140	36	6.3	111	15.9	15.9	-

## CYLINDRICAL FUSE-LINKS

**TYPE LPV**

### 400/500/660 Volt Cylindrical Fuse-Links to IEC60269-2

Rated voltages: 400V a.c., 500V a.c., 660V a.c. Breaking range and utilization category: gG/aM/aR Rated breaking capacities: 20kA a.c., 80kA a.c., 120kA a.c.

#### Voltage and current ratings and principal dimensions



Lawson Type "LPV" fuse-links with cylindrical bodies and ferrule end caps are used widely in both commercial and industrial applications. Cylindrical fuse-links are approved to IEC 60269, and are available in both gG and aM operating categories.

A complementary range of solid/neutral links is available to suit our fuse-link range.

Voltage Rating (V a.c.)	Breaking Capacity (kA)	Current Rating (A)	List References			Principal Dimensions (mm)	
			Standard	Indicator	Striker	L	D
400	20	1,2,4,6,8,10,12,16,20,25	LPVG8	LPVG8I	-	31	8
500	120	1,2,4,6,8,10,12,16,20,25,32	LPVG10	LPVG10I	-	38	10
660	80	1,2,4,6,8,10,12,16,20,25	LPVG14	LPVG14I	LPVG14S	51	14
500	120	32,40					
400	120	50					
660	80	4,6,8,10,12,16,20,25,32,40,50,63,80	LPVG22	LPVG22I	LPVG22S	58	22
500	120	100					
400	120	125					

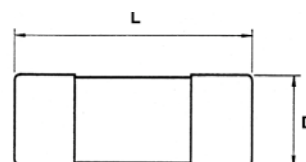
**Note:**

1. A range of fuse-links for motor circuit protection is available, substitute M for G in list references.
2. Fuse-links for semi-conductor protection and a range of fuse-holders, together with accessories, are also available.

## GENERAL PURPOSE FUSE-LINKS

**TYPE MD**

### 400/415 Volt General Purpose Fuse-Links to BS88: Part 1 • IEC60269-1

Rated voltages: 415V a.c., 250V d.c. Breaking range and utilization category: gG Rated breaking capacities: 80kA at 415V a.c., 40kA at 250V d.c.

#### Current ratings and principal dimensions

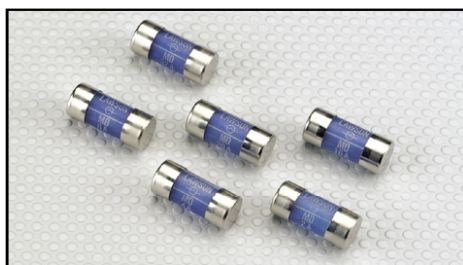

Lawson Type "MD" cylindrical fuse-links are for general purpose usage in three-phase sub-circuits. With a breaking capacity of 80kA, type "MD" fuse-links can be used to protect circuits with high fault levels such as industrial installations. The fuse-links also meet the performance requirements of BS88: Part 2 and IEC 60269-2 and have been independently ASTA Certified to the rules of the ASTA 20 Scheme.

Current Rating (A)	List Reference	Principal Dimensions		Carton Quantity	Carton Weight (Kg)
		L mm	D mm		
2	MD2	29	12.7	10	0.10
4	MD4				
6	MD6				
8	MD8				
10	MD10				
16	MD16				
20	MD20				
25	MD25				
32	MD32				

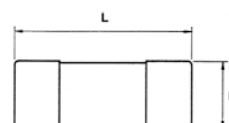

## LOW VOLTAGE MINIATURE FUSE-LINKS

## TYPE MIN

### 200/240 Volt miniature Fuse-Links generally to IEC127

Rated voltage: 250V a.c. Rated breaking capacity: Various.

#### Current ratings and principal dimensions

DIMENSION MM	OPERATING CHARACTERISTIC	BODY MATERIAL	TYPE REF	RATING		FUSE- HOLDER TYPE	CARTON QUANTITY
				mA	AMPS		
5 X 20	FAST	GLASS	PDC	32, 40, 50, 63, 80, 100, 125, 160, 200, 250, 315, 400, 500, 630, 800	1, 1.25, 1.6, 2, 2.5, 3.15, 4, 5, 6, 3, 8, 10, 15	KP	100 (10x10)
		CERAMIC	PCC	32, 40, 50, 63, 80, 100, 125, 160, 200, 250, 315, 400, 500, 630, 800	1, 1.25, 1.6, 2, 2.5, 3.15, 4, 5, 6, 3, 8, 10		
	SLOW	GLASS	PDC-S	32, 40, 50, 63, 80, 100, 125, 160, 200, 250, 315, 400, 500, 630, 800	1, 1.25, 1.6, 2, 2.5, 3.15, 4, 5, 6, 3, 8, 10		
		CERAMIC	PCC-S	125, 160, 200, 250, 315, 400, 500, 630, 800	1, 1.25, 1.6, 2, 2.5, 3.15, 4, 5, 6, 3, 8, 10		
	ULTRA-FAST		PCC-UR		1.6, 2, 3, 15, 4, 5, 8, 10		
6.3 X 32	FAST	GLASS	KDC	10, 32, 40, 63, 100, 125, 150, 175, 187, 200, 250, 300, 375, 500, 600, 750	1, 1.25, 1.5, 1.6, 2, 2.5, 3, 4, 5, 6, 7, 8, 10	K	100 (10x10)
		CERAMIC	KCC	125, 250, 375, 500, 750	1, 2, 3, 4, 5, 6, 7, 8, 10, 12, 15, 20, 25, 30		
	SLOW	GLASS	KDC-S	10, 32, 40, 63, 100, 125, 150, 175, 187, 200, 250, 300, 375, 400, 500, 600, 700, 750, 800	5, 6, 7, 8, 20, 25, 30		
		CERAMIC	KCC-S	10, 32, 63, 100, 125, 150, 175, 187, 200, 250, 300, 375, 400, 500, 600, 700, 750, 800	1, 1.25, 1.5, 1.6, 2, 2.5, 3, 4, 5, 6, 7, 8, 10, 12, 15, 20, 25, 30		
ULTRA-FAST			KCC-UR		1, 1.25, 2, 3, 4, 5, 6, 7, 8, 10, 12, 15, 20, 25, 30		
5 X 25	FAST	GLASS	TDC	80, 100, 125, 160, 200, 250, 315, 400, 500, 630, 800	1, 1.25, 1.6, 2, 2.5, 3.15, 4, 5, 6, 3, 8, 10		
		CERAMIC C/W INDICATOR	TCC		1.6, 2, 2.5, 3, 15, 4, 5, 6, 3, 8, 10		
		GLASS	TDC-M	80, 100, 125, 160, 200, 250, 315, 400, 500, 630, 800	1, 1.25, 1.6, 2, 2.5, 3.15, 4, 5, 6, 3, 8, 10		
		CERAMIC C/W INDICATOR	TCC-M	80, 100, 125, 160, 200, 250, 315, 400, 500, 630, 800	1, 1.25, 1.6, 2, 2.5, 3.15, 4, 5, 6, 3, 8, 10,		



Lawson Type "MIN" fuse-links are available to meet a wide variety of applications. Miniature and other small dimensioned fuse-links are grouped into several different application categories and comply with different specifications. Many different types are available with current ratings from 10mA to 30 Amps.





## OPERATING CHARACTERISTICS

## TYPE ME & MF

### House Service Type ME & MF - Time/Current

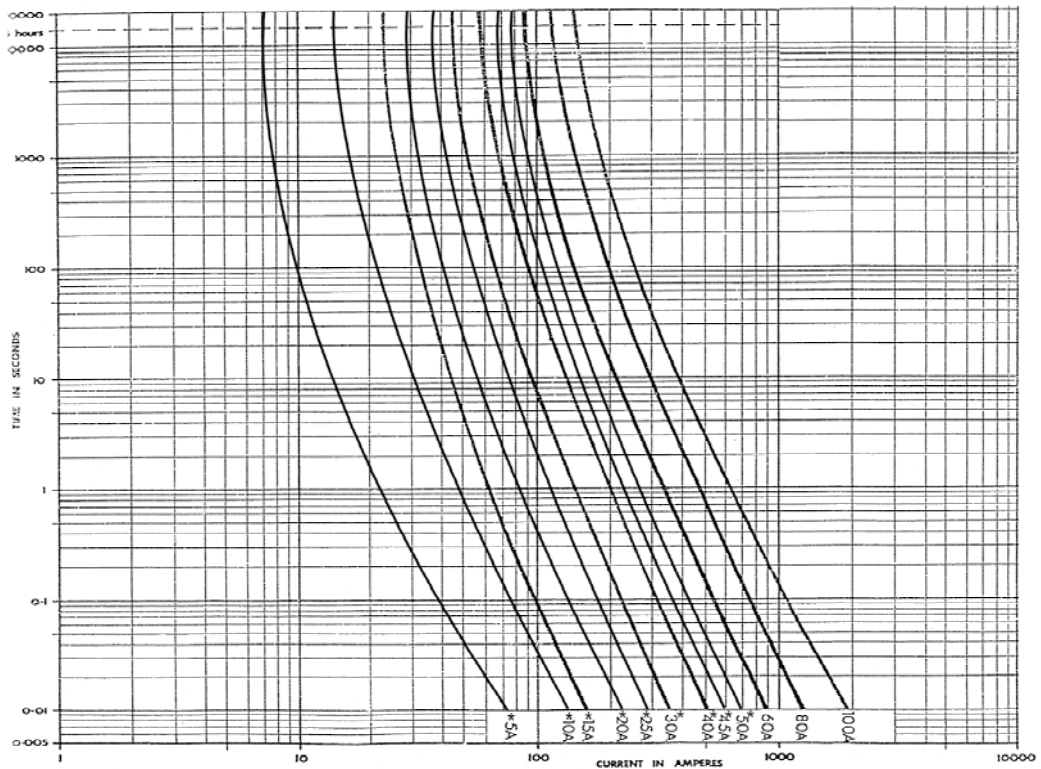

\* NON STANDARDIZED CURRENT RATINGS TO BS 1361:1971

### Type ME & MF - Cut-Off Current

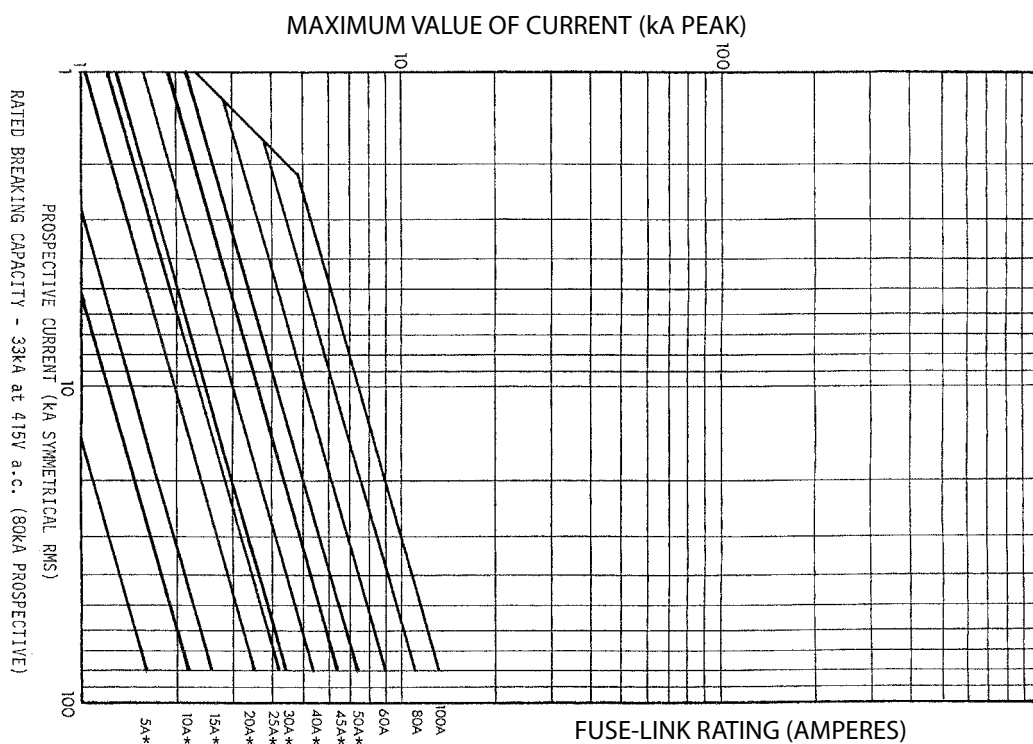

\* NON STANDARDIZED CURRENT RATINGS TO BS 1361:1971

## APPLICATION DATA

One of the long standing advantages of fuse protection is that fuse selection is relatively simple and effective.

The following notes should cover the majority of applications.

Reference should also be made to the appropriate Wiring Installation rules, such as the IEE Wiring Regulations for Electrical Installation of buildings (BS7671) which aligns with IEC60364.

### Circuit Loading

The current rating of the fuse-link should not be less than the full load current of the circuit. The circuit should be so designed that small overloads of long duration will not be of frequent occurrence.

### Protection Against Electrical Shock

The rules for protection against indirect contact are given in Chapter 41 of the wiring regulations. For a TN System a disconnecting time not exceeding 5 seconds is permitted for a distribution circuit. The maximum values of each fault loop impedance ( $Z_s$ ) of 240V for gG fuse-links to BS88: Parts 2 and 6 are shown below.

Rating (A)	$Z_s$ (Ohms)	Ratings (A)	$Z_s$ (Ohms)
6	14	100	0.44
10	7.7	125	0.35
16	4.3	160	0.27
20	3.0	200	0.20
25	2.4	250	0.16
32	1.9	315	0.13
40	1.4	400	0.092
50	1.1	500	0.067
63	0.86	630	0.056
80	0.60	800	0.035

### Ambient Temperature

Above an ambient of 40°C a general de-rating of 0.5% of the fuse-link rated current per excess degree centigrade is recommended.

### Breaking Capacity

The standardized values of Breaking Capacity for fuse-links to BS88 are 80kA for voltages of 415V a.c., and above, and 40kA for d.c., applications. The 240V a.c., designs have a breaking capacity of 16kA minimum.

### Harmonised Voltage Ratings

The voltage ratings of all Lawson fuses are compatible with the proposed harmonised voltage ratings of 230V a.c., 400V a.c., and 690V a.c.

### Discrimination

All fuse-links to BS88 have a discrimination ratio of 1.6: 1. For example, an upstream fuse-link rated at 160A will discriminate with a downstream fuse-link rated at 100A.

### Current and Energy Limitation

The Lawson range of fuse-links have pre-arcing  $I^2t$  values towards the lower limits of BS88 ensuring excellent current and energy limitation. They also have power losses at rated current significantly lower than the standardized limits which assists in the appropriate interchangeability with other makes of fuse-links.

### Cable Ratings and Protection

Lawson fuse-links with gG characteristics protect associated cables against both overload and short circuit currents, provided that the current rating of the fuse-link  $I_n$  is equal to or less than the current carrying capacity of the cable  $I_z$ .

There is an increasing move away from 70°C pvc insulation to materials, which are more environmentally friendly for example 90°C XLPE. The ratings of fusegear, switches, accessories etc. are generally based upon the equipment being connected to conductors intended to be operated at a temperature not exceeding 70°C in normal service.

In view of the above it is recommended that the practice of designs based upon conductor temperatures of 70°C be regarded as the norm. In accordance with the Wiring Regulations, the equipment manufacturer should be consulted to ascertain the reduction of nominal current rating of the equipment if conductor temperatures exceeding 70°C are used.

Cable Size (mm <sup>2</sup> )	Max.Fuse Rating	
	K=115 A	K=143 A
1	16	16
1.5	20	25
2.5	32	32
4	50	50
6	63	63
10	100	125
16	125	160
25	200	250
35	315	355
50	400	500
70	560	630
95	710	800
120	800	1000

## APPLICATION DATA

In motor circuits, the motor starter provides the overload protection and the fuse-link provides the short circuit protection. The maximum size of fuse-link that can be used depends upon the type of cable used and is determined in accordance with the Wiring Regulations using the appropriate K factor. The table gives the maximum sizes of fuse-links that are recommended for two popular cables with copper conductors, 70°C pvc (K = 115) and 90°C thermo-setting (K = 143).

### Transformers

When fuse-links are used on the primary side of transformers the normal current rating of the fuse-link should be at least twice the nominal transformer primary current.

### Fluorescent Lighting

The normal current rating of the fuse-link should be at least twice the normal full load current of the maximum number of lights to be switched simultaneously.

### Capacitor Circuits

In capacitor circuits, eg. power factor correction, the fuse-link should be chosen with a current rating greater than 1.5 times the rated capacitor current. This takes account of the high transient inrush current, circuit harmonics and capacitor tolerances.

### Type 2 Co-ordination

Motor starter manufacturers recommend the fuse-link rating that can be used in conjunction with motor starters. These recommendations usually do not state any specific fuse-link manufacturers type number and they often refer to gG fuse-links in accordance with IEC 60269 or the equivalent national standards e.g. BS88: part 2. This gives a simple and effective means of co-ordination since a fuse-link selected in accordance with manufacturers' recommendations to withstand inrush currents will normally give adequate short circuit protection to the motor starter.

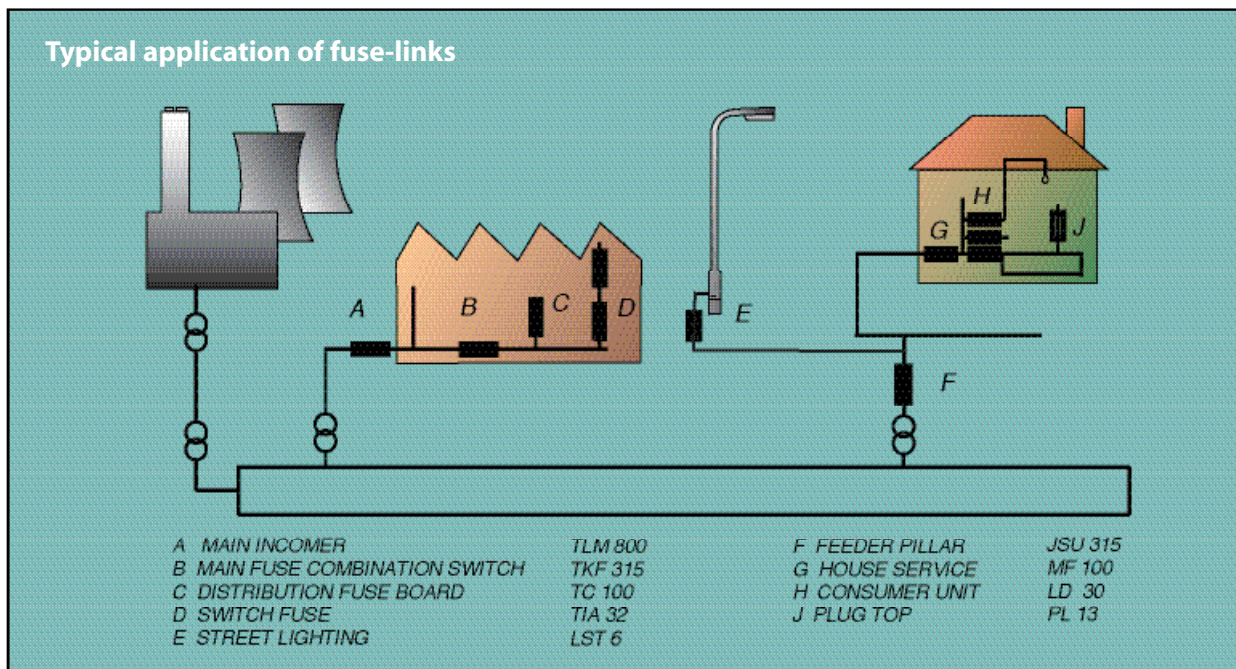

Dimensionally Comparative Types of Low Voltage B.S. HRC Cartridge Fuse-Links								
LAWSON	GEC-EE GE	HAWKER BRUSH BUSSMANN	DORMAN BUSSMANN	MEM	FLUVENT	REYROLLE IND ACCS	EMP	OLD GEC
PL	-	PTC	DSF	-	-	-	-	-
LA	D5	C55	DSDF5	LC'	-	LA	-	Y-A
LC	D15	C1515/C1520	DSD15	LC	-	LC	-	Y-B
LD	D30	C3030	DSD30	LC	-	LD	-	Y-C
LK	D4545	C4545	DSD45	LCS	-	LK	-	Y-K
MD	-	-	-	-	-	MD	-	-
ME	RH	KR71 KR85	RHD	R	CSK	LE GPE-20E	LR ER	Y-D
MF	RHL	LR71 LR85	RHLD RHLC	RL	CSG	-	-	Y-L
SS	SS	DO4	SSD	SS	-	RSS	MS	-
LST	LST	D19L	STD	LS	-	RLST	MSG	-
NIT	NIT	F21	NITD	SA2	FOBX	RIT	MNG	Y-PAX Y-QAX
NS	NS	F06	NSD	SN2	F986	RS	MN	Y-PF Y-QF
GTIA TIA	TIA	HO7	AAO	SB2 SB3	FOMX	RIA	MANN	Y-RA
MES	ES	ESD	ESD/ESC	SP	-	-	-	-
TIS	TIS OS	KO7	BAO OSD	SB4 SO	FOSX	RIS	MARW	Y-SA
TB	TB	KO8	AC BC	SE3 SE4	F754/M F754/S	RB	MARC	Y-SB
TBC	TBC	KO9	AD BD	SF3 SF4	F755/M F755/S	RBC	MARL	Y-SBL
TCP	TCP	L14	CEO	SD5	FO1X F763/MX F763/SX	RCP	ENAA	Y-TA
TC	TC	LO9	CD	SF5	FB1	RC	EAA	Y-TB
TFP	TFP	M14	DEO	SD6	F763/2X	RFP	ENA	Y-VAD
TF	TF	MO9	DD	SF6	FB2	RF	EA	Y-VB
84TF	84TF	M13	-	SW6	-	-	EAS	Y-VAS
TKF	TKF	NO9	ED	SF7	FB3	RKF	EB	Y-WB
84TK	84TK	N15	-	SW7	-	-	EJBS	Y-WAS
TMF	TMF	PO9	ED	SF8	FB4	RMF	EBC	Y-XBD
TKM	TKM	N11	EFS	SG7	F772/3	RKM	EBL	Y-WBL
TM	TM	P11	EF	SH8	F773/4	RM	EBCL	Y-XB
TMT	TMT	P12	-	-	F781/4	-	EBCX	Y-XBL
85TM	85TM	P20	ES	SX8	-	-	EBCH	Y-XA
TTM	TTM	R11	FF	SH9	FB6	RTM	EC	Y-YB
TT	TT	R12	FG	SY9	F781/6	-	ECW	Y-YBL Y-ZB
86TT	86TT	R20 S20	FS	SX9	-	-	ECH	Y-YA
TLM	TLM	S11	GF	SH10	FB6 F851/8	RLM	EDN	Y-ZBD
TLU	TLU	GH	-	-	-	-	-	-
TLT	TLT	S12	GG	SY10	F781/8	-	ED	Y-ZB
JH	JH	MJ26	JHD	-	-	-	-	-
JHU	96TY	MJ29	JHDS	JW6 JWS6	DL1-2 DL1-3	-	1/EJA 1S/EJA	-
JP	JP	MJ27	JPD	-	-	-	-	-
JPU	95TY 95TJ 171TN	MJ27 MJ30 PJ30	JPDS JOPCS J1PCS J2PCS	JX6 JX7 JX8 JXS6 JXS7 JXS8	DL2-2 DL2-3 DL2-4 DL2-6	-	2/EJA 2/EJB 2S/EJA 2S/EJB	-
JS	JS	MJ28 PJ28 SJ28	JSD	-	-	-	-	-
JSU	385TJ 386TN 387TW	MJ31 PJ31 SJ31	JSDS JOSCS J1SCS J2SCS J3SCS	JY7 JY8 JY10 JYS7 JYS8 JYS10	DL3-2 DL3-3 DL3-4 DL3-6 DL3-8	-	3/EJB 3/EJBC 3/EJC 3S/EJB 3S/EJBC 3S/EJC	-
JF	FHLA	MJ25	-	-	-	-	-	-



**Dimensionally Comparative Types of Low Voltage N.H. HRC Cartridge Fuse-Links**

LAWSON REF	HAWKER BRUSH	LINDNER	SIEMENS NEW	SIEMENS OLD	SIBA	J.MULLER	SIEGER JUNG	EFEN	GEC	LE GRAND	ELCO	SCHNEIDER
LSPN0006	6NHC00B	7999.0067	3NA3801	3NA1011	20000136	M00CgL6	-	35000.006	-	-	-	370606
LSPN00010	10NHC00B	7999.0107	3NA3803	3NA1012	200001310	M00CgL10	-	35000.01	NHG00C/010	-	VN000C10	370610
LSPN00016	16NHC00B	7999.0167	3NA3805	3NA1013	200001316	M00CgL16	-	35000.016	NHG00C/016	-	VN000C16	370616
LSPN00020	20NHC00B	7999.0207	3NA3807	3NA1014	200001320	M00CgL20	-	35000.02	NHG00C/020	-	VN000C20	370620
LSPN00025	25NHC00B	7999.0257	3NA3810	3NA1015	200001325	M00CgL25	-	35000.025	NHG00C/025	-	VN000C25	370625
LSPN00032	32NHC00B	7999.0327	3NA3812	-	-	M00CgL32	-	-	-	-	-	370632
LSPN00040	40NHC00B	7999.0407	3NA3817	-	-	M00CgL40	-	-	-	-	-	370640
LSPN00050	50NHC00B	7999.0507	3NA3820	3NA1017	200001350	M00CgL50	-	35000.05	NHG00C/050	-	VN000C50	370650
LSPN00063	63NHC00B	7999.0637	3NA3822	3NA1018	200001363	M00CgL63	-	35000.063	NHG00C/063	-	VN000C63	370663
LSPN0010	-	-	-	-	-	M00gL10	100010	35011.004	NHG00/010	16310	VN00010	370610
LSPN0016	-	-	-	-	-	M00gL16	100016	35011.005	NHG00/016	16316	VN00016	370616
LSPN0020	-	-	-	-	-	M00gL20	100020	35011.006	NHG00/020	16315	VN00020	370620
LSPN0025	-	-	-	-	-	M00gL25	100025	35011.007	NHG00/025	16318	VN00025	370625
LSPN0032	-	-	-	-	-	-	100032	35011.008	-	16320	-	370632
LSPN0040	-	-	-	-	-	-	100040	35011.01	-	16325	-	370640
LSPN0050	-	-	-	-	-	M00gL50	100050	35011.011	NHG00/050	16330	VN00050	370650
LSPN0063	-	-	-	-	-	M00gL63	100060	35011.012	NHG00/063	16335	VN00063	370663
LSPN0080	-	-	3NA3824	-	200001380	-	100080	35011.013	NHG00/080	16340	VN00080	370680
LSPN00100	-	-	3NA3830	-	2000013100	-	100100	35011.014	NHG00/100	16345	VN000100	370690
LSPN00125	125NH00B	7999.1257	3NA3832	-	2000013125	M00gL125	100125	35011.015	NHG00/125	16350	VN000125	370692
LSPN00160	160NH00B	7999.1607	3NA3836	-	2000013160	M00gL160	100160	35011.016	NHG00/160	16355	-	370096
LSPN032	32NH0B	8000.0327	3NA3012	-	-	M0gL32	110032	-	-	-	-	378032
LSPN040	40NH0B	8000.0407	3NA3017	-	-	M0gL40	110040	-	-	16825	-	378040
LSPN050	50NH0B	8000.0507	3NA3020	3NA1117	200021350	M0gL50	110050	35029.007	NHG0/050	16830	VN0050	378050
LSPN063	63NH0B	8000.0637	3NA3022	3NA1118	200021363	M0gL63	110063	35029.008	NHG0/063	16835	VN0063	378063
LSPN080	80NH0B	8000.0807	3NA3024	3NA1120	200021380	M0gL80	110080	35029.009	NHG0/080	16840	VN0080	378080
LSPN0100	100NH0B	8000.1007	3NA3030	3NA1121	2000213100	M0gL100	110100	35029.01	NHG0/100	16845	VN00100	378090
LSPN0125	125NH0B	8000.1257	3NA3032	3NA1122	2000213125	M0gL125	110125	35029.011	NHG0/125	16850	VN00125	378092
LSPN0160	160NH0B	8000.1607	3NA3036	3NA1124	2000213160	M0gL160	110160	35029.012	NHG0/160	16855	VN00160	378096
LSPN132	32NH1B	8001.0327	-	-	-	M1gL32	101032	-	-	-	-	371625
LSPN140	40NH1B	8001.0407	3NA3117	-	-	M1gL40	101040	-	-	-	-	371640
LSPN150	50NH1B	8001.0507	3NA3120	3NA1202	200031350	M1gL50	101050	35035.007	NHG1/050	-	VN0150	371650
LSPN163	63NH1B	8001.0637	3NA3122	3NA1218	200031363	M1gL63	101063	35035.008	NHG1/063	-	VN0163	371663
LSPN180	80NH1B	8001.0807	3NA3124	3NA1220	200031380	M1gL80	101080	35035.009	NHG1/080	17340	VN0180	371680
LSPN1100	100NH1B	8001.1007	3NA3130	3NA1221	2000313100	M1gL100	101100	35035.01	NHG1/100	17345	VN01100	371090
LSPN1125	125NH1B	8001.1257	3NA3132	3NA1222	2000313125	M1gL125	101125	35035.011	NHG1/125	17350	VN01125	371092
LSPN1160	160NH1B	8001.1607	3NA3136	3NA1224	2000313160	M1gL160	101160	35035.012	NHG1/160	17355	VN01160	371096
LSPN1200	200NH1B	8001.2007	3NA3140	3NA1225	2000313200	M1gL200	101200	35035.013	NHG1/200	17360	VN01200	371320
LSPN1250	250NH1B	8001.2507	3NA3144	3NA1227	2000313250	M1gL250	101250	35035.015	NHG1/250	17365	VN01250	371325
LSPN240	40NH2B	8002.0407	-	-	-	M2gL40	102040	-	-	-	-	372604
LSPN250	50NH2B	8002.0507	-	-	200041350	M2gL50	102050	35054.003	NHG2/050	-	VN0250	372605
LSPN263	63NH2B	8002.0637	-	-	200041363	M2gL63	102063	35054.004	NHG2/063	-	VN0263	372606
LSPN280	80NH2B	8002.0807	3NA3224	3NA1320	200041380	M2gL80	102080	35054.005	NHG2/080	-	VN0280	372608
LSPN2100	100NH2B	8002.1007	3NA3230	3NA1321	2000413100	M2gL100	102100	35054.006	NHG2/100	-	VN02100	372610
LSPN2125	125NH2B	8002.1257	3NA3232	3NA1322	2000413125	M2gL125	102125	35054.007	NHG2/125	17850	VN02125	372612
LSPN2160	160NH2B	8002.1607	3NA3236	3NA1324	2000413160	M2gL160	102160	35054.008	NHG2/160	17855	VN02160	372616
LSPN2200	200NH2B	8002.2007	3NA3240	3NA1325	2000413200	M2gL200	102200	35054.009	NHG2/200	17860	VN02200	372620
LSPN2250	-	-	-	3NA1327	2000413250	-	102250	35054.011	NHG2/250	17865	VN02250	372625
LSPN2315	315NH2B	8002.3157	3NA3252	3NA1328	2000413315	M2gL315	102315	35054.013	NHG2/315	17870	VN02315	372231
LSPN2350	-	-	-	-	2000413355	-	102355	35054.014	-	17872	-	372235
LSPN2400	400NH2B	8002.4007	3NA3260	3NA1332	2000413400	M2gL400	102400	35054.015	NHG2/400	17875	VN02400	372240
LSPN3350	-	-	-	-	2000513355	-	-	35078.002	-	-	-	373640
LSPN3400	400NH3B	8003.4007	3NA3360	3NA1432	2000513400	M3gL400	103400	35078.003	NHG3/400	-	VN03400	373042
LSPN3500	500NH3B	8003.5007	3NA3365	3NA1434	2000513500	M3gL500	103500	35078.005	NHG3/500	18125	VN03500	373050
LSPN3630	630NH3B	8003.6307	3NA3372	3NA1436	2000513630	M3gL630	103630	35078.006	NHG3/630	18130	VN03630	373063

## COMPARATIVE TYPES OF LOW VOLTAGE DO&amp;D BOTTLE FUSE-LINKS

## Comparison DO Fuse-Links

LAWSON	SIEMENS	SIBA	IFO	MOELLER	AEI AED	BROADWAY	BUSSMANN HAWKER	LINDNER
2LNZ11-400	5SE2002	-	-	-	-	2ND01	2NZ01	1700.002
4LNZ11-400	5SE2004	-	-	-	-	4ND01	4NZ01	1700.004
6LNZ11-400	5SE2006	-	-	-	-	6ND01	6NZ01	1700.006
10LNZ11-400	5SE2010	-	-	-	-	10ND01	10NZ01	1700.01
16LNZ11-400	5SE2016	-	-	-	-	16ND01	16NZ01	1700.016
20LNZ15-400	5SE2020	-	-	-	-	20ND02	20NZ01	1701.02
25LNZ15-400	5SE2025	-	-	-	-	25ND02	25NZ02	1701.025
35LNZ15-400	5SE2035	-	-	-	-	35ND02	25NZ02	1701.035
50LNZ15-400	5SE2050	-	-	-	-	50ND02	35NZ02	1701.05
63LNZ15-400	5SE2063	-	-	-	-	63ND02	50NZ02	1701.063
80LNZ22-400	5SE2080	-	-	-	-	80ND03	63NZ02	1702.08
100LNZ22-400	5SE2100	-	-	-	-	100ND03	-	1702.1
2LNZ11-440	-	-	-	-	-	-	-	1700.0024
4LNZ11-440	-	-	-	-	-	-	-	1700.0044
6LNZ11-440	-	-	-	-	-	-	-	1700.0064
10LNZ11-440	-	-	-	-	-	-	-	1700.0104
16LNZ11-440	-	-	-	-	-	-	-	1700.0164
20LNZ15-440	-	-	-	-	-	-	-	1701.0204
25LNZ15-440	-	-	-	-	-	-	-	1701.0254
35LNZ15-440	-	-	-	-	-	-	-	1701.0354
50LNZ15-440	-	-	-	-	-	-	-	1701.0504
63LNZ15-440	-	-	-	-	-	-	-	1701.0634

## Comparison D Fuse-Links

2LD12	5SA2-11	1000204-2	-	2+4-11140	TNDZ2	-	2D16	594.0027
4LD12	5SA2-21	1000204/4	-	2+4-11140	TNDZ4	-	4D16	594.0047
6LD12	5SA2-31	1000204/6	-	6-11140	TNDZ6	-	6D16	594.0067
10LD12	5SA251	1000204/10	-	10-11140	TNDZ10	-	10D16	594.0107
16LD12	5SA2-61	1000204/16	-	16-11140	TNDZ16	-	16D16	594.0167
20LD12	5SA2-71	1000204/20	-	20-11140	TNDZ20	-	20D16	594.0207
25LD12	5SA2-81	1000204/25	-	25-11140	TNDZ25	-	25D16	594.0257
2LD22	5SB2-11	1000504/2	TDNS502	2+4-1104	TDZ2	2FE27D11	2D27	597.0027
4LD22	5SB2-21	1000504/4	TDNS504	2+4-1104	TDZ4	4FE27D11	4D27	597.0047
6LD22	5SB2-31	1000504/6	TDNS506	6-1104	TDZ6	6FE27D11	6D27	597.0067
10LD22	5SB2-51	1000504/10	TDNS510	10-1104	TDZ10	10FE27D11	10D27	597.0107
16LD22	5SB2-61	1000504/16	TDNS516	16-1104	TDZ16	16FE27D11	16D27	597.0167
20LD22	5SB2-71	1000504/20	TDNS520	20-1104	TDZ20	20FE27D11	20D27	597.0207
25LD22	5SB2-81	1000504/25	TDNS525	25-1104	TDZ25	25FE27D11	25D27	597.0257
35LD27	5SB4-11	1000704/35	TDSS535	35-12040	TDZ35	35FE33D111	35D33	598.0357
50LD27	5SB4-21	1000704/50	TDSS550	50-12040	TDZ50	50FE33D111	50D33	598.0507
63LD27	5SB4-31	1000704/63	TDSS563	63-12040	TDZ63	63FE33D111	63D33	598.0637
80LD37	5SC2-11	1000904/80	TDSS580	80-13040	TDZ80	80FR1D1V	80D125	595.0807
100LD37	5SC2-21	1000904/100	TDSS5100	100-13040	TDZ100	100FR1D1V	100D125	595.1007
125LD51	5SC4-31	-	-	-	-	-	-	596.1257
160LD51	5SC4-41	-	-	-	-	-	-	596.1607
200LD51	5SC4-51	-	-	-	-	-	-	596.2007

## Comparison D Fuse-Links (Quick Acting)

2LD12Q	5SA1-11	1000201/2	-	2+4-1114	NDZ2	2SE16D	2D16Q	594.002
4LD12Q	5SA1-21	1000201/4	-	2+4-1114	NDZ4	4SE16D	4D16Q	594.004
6LD12Q	5SA1-31	1000201/9	-	6-1114	NDZ6	6SE16D	6D16Q	594.006
10LD12Q	5SA1-51	1000201/10	-	10-1114	NDZ10	10SE16D	10D16Q	594.01
16LD12Q	5SA1-61	1000201/16	-	16-1114	NDZ16	16SE16D	16D16Q	594.016
20LD12Q	5SA1-71	1000201/20	-	20-1114	NDZ20	20SE16D	20D16Q	594.02
25LD12Q	5SA1-81	1000201/25	-	25-1114	NDZ25	25SE16D	25D16Q	594.25
2LD22Q	5SB1-11	1000501/2	DNS502	2+4-1104	Z4221	2SE27D11	2D27Q	597.002
4LD22Q	5SB1-21	1000501/4	DNS504	2+4-1104	Z4222	4SE27D11	4D27Q	597.004
6LD22Q	5SB1-31	1000501/6	DNS506	6-1104	Z4223	6SE27D11	6D27Q	597.006
10LD22Q	5SB1-41	1000501/10	DNS510	10-1104	Z4224	10SE27D11	10D27Q	597.01
16LD22Q	5SB1-61	1000501/16	DNS516	16-1104	Z4225	16SE27D11	16D27Q	597.016
20LD22Q	5SB1-71	1000501/20	DNS520	20-1104	Z4226	20SE27D11	20D27Q	597.02
25LD22Q	5SB1-81	1000501/25	DNS525	25-1104	Z4227	25SE27D11	25D27Q	597.025
35LD27Q	5SB3-11	1000701/35	DSS535	35-1204	Z4228	35SE27D111	35D33Q	598.035
50LD27Q	5SB3-21	1000701/50	DSS550	50-1204	Z4229	50SE33D111	50D33Q	598.05
63LD27Q	5SB3-31	1000701/63	DSS563	63-1204	Z60500T	63SE33D111	63D33Q	598.063
80LD37Q	5SC1-11	1000901/80	DSS580	80-1304	Z80500T	80SR1D1V	80D125Q	595.08
100LD37Q	5SC1-21	1000901/100	DSS5100	100-1304	Z100500T	100SR1D1V	100D125Q	595.1

## COMPARATIVE TYPES OF LOW VOLTAGE CYLINDRICAL CARTRIDGE FUSE-LINKS

LAWSON	LEGRAND	FERRAZ	IFO	HAZEMEYER	SIBA	FUSES - SJ	GEC
LPVG102	13302	D213098	16013	1038GL2	5006308/2	15011.002	10G02
LPVG104	13304	X213598	16019	1038GL4	5006308/4	15011.004	10G04
LPVG106	13306	K215128	16023	1038GL6	5006308/6	15011.006	10G06
LPVG1010	13310	S218194	16031	1038GL10	5006308/10	15011.01	10G10
LPVG1012	13312	W219761	16033	1038GL12	5006308/12	15011.012	10G12
LPVG1016	13316	G200750	16035	1038GL16	5006308/16	15011.016	10G16
LPVG1020	13320	D211028	16037	1038GL20	5006308/20	15011.02	10G20
LPVG1025	13325	E213099	16039	1038GL25	5006308/25	15011.025	10G25
LPVG1032	-	A214107	16043	1038GL32	5006308/32	15011.032	10G32

LPVG142	14302	Y219234	17013	1451GL2	5005808/2	15111.002	14H02
LPVG144	14304	A219765	17019	1451GL4	5005808/4	15111.004	14G04
LPVG146	14306	H222210	17023	1451GL6	5005808/6	15111.006	14G06
LPVG1410	14310	L200754	17031	1451GL10	5005808/10	15111.01	14G10
LPVG1412	14312	L201812	17033	1451GL12	5005808/12	15111.012	14G12
LPVG1416	14316	A211554	17035	1451GL16	5005808/16	15111.016	14G16
LPVG1420	14320	Z212588	17037	1451GL20	5005808/20	15111.02	14G20
LPVG1425	14325	C213603	17039	1451GL25	5005808/25	15111.025	14G25
LPVG1432	14332	W216656	17043	14541GL32	5005808/32	15111.032	14G32
LPVG1440	14340	X218198	17047	1451GL40	5005808/40	15111.04	14G40
LPVG1450	14350	Z219235	17051	1451GL50	-	15111.05	14G50

LPVG2216	15316	S201818	18035	22589L16	5006008/16	15211.16	22G16
LPVG2220	15320	P211038	18037	22589L20	5006008/20	15211.2	22G20
LPVG2225	15325	N212072	18039	22589L25	5006008/25	15211.25	22G25
LPVG2232	15332	F212594	18043	22589L32	5006008/32	15211.32	22G32
LPVG2240	15340	J213609	18047	22589L40	5006008/40	15211.4	22G40
LPVG2250	15350	P214626	18051	22589L50	5006008/50	15211.5	22G50
LPVG2263	15363	Y215646	18055	22589L63	5006008/63	15211.63	22G63
LPVG2280	15380	Q217180	18059	22589L80	5006008/80	15211.8	22G80
LPVG22100	153100	E218205	18063	22589L100	5006008/100	15211.1	22G100
LPVG22125	-	J219773	-	-	-	-	-

LPVM104	13004	W219232	16519	1038aM4	5006307/4	15021.004	-
LPVM106	13006	F222208	16523	1038aM6	5006307/6	15021.006	-
LPVM108	13008	Z201295	16527	1038aM8	5006307/8	15021.008	-
LPVM1010	13010	Y211552	16531	1038aM10	5006307/10	15021.01	-
LPVM1012	13012	A213601	16533	1038aM12	5006307/12	15021.012	-
LPVM1016	13016	F214618	16565	1038aM16	5006307/16	15021.016	-
LPVM1020	13020	X216151	16537	1038aM20	5006307/20	15021.02	-
LPVM1025	13025	G217172	16539	1038aM25	5006307/25	-	-
LPVM1032	-	J218715	-	-	-	-	-

LPVM144	14004	K214622	17519	1451aM4	5005807/4	15121.004	-
LPVM146	14006	S215135	17523	1451aM6	5005807/6	15121.006	-
LPVM148	14008	T215642	17527	1451aM8	5005807/8	15121.008	-
LPVM1410	14010	Z216659	17531	1451aM10	5005807/10	15121.01	-
LPVM1412	14012	M217177	17533	1451aM12	5005807/12	15121.012	-
LPVM1416	14016	Q217686	17535	1451aM16	5005807/16	15121.016	-
LPVM1420	14020	P218720	17537	1451aM20	5005807/20	15121.02	-
LPVM1425	14025	E219769	17539	1451aM25	5005807/25	15121.025	-
LPVM1432	14032	M222214	17543	1451aM32	5005807/32	15121.032	-
LPVM1440	14040	Q200758	17547	1451aM40	5005807/40	15121.04	-
LPVM1450	14050	E211558	17551	1451aM50	-	15121.05	-

LPVM2216	15016	M211565	18535	2258aM16	50067/16	15221.016	-
LPVM2220	15020	S212076	18537	2258aM20	50067/20	15221.02	-
LPVM2225	15025	J212597	18539	2258aM25	50067/25	15221.025	-
LPVM2232	15032	V213113	18543	2258aM32	50067/32	15221.032	-
LPVM2240	15040	N213613	18547	2258aM40	50067/40	15221.04	-
LPVM2250	15050	R214122	18551	2258aM50	50067/50	15221.05	-
LPVM2263	15063	C215650	18555	2258aM63	50067/63	15221.063	-
LPVM2280	15080	H216667	18559	2258aM80	50067/80	15221.08	-
LPVM22100	15096	Y217693	18563	2258aM100	50067/100	15221.1	-
LPVM22125	-	J218209	-	-	-	-	-