

HFV6**AUTOMOTIVE RELAY****Typical Applications**

Lighting control, Headlight control, Electromagnet control
Air-conditioning, Heaters (seat, front/rear windows),
Fan motors control, Fuel pump control, Wiper motors control

Features

- 30A switching capability
- Ambient temp. range up to 125°C
- 1 Form A & 1 Form C contact arrangement
- Plastic sealed and dust protected types available
- RoHS & ELV compliant

CHARACTERISTICS

Contact arrangement	1A, 1C	Flammability ⁶⁾	UL94-HB or better (meets FMVSS 302)
Voltage drop (initial)	NO:Typ.15mV,250mV max.(at 10A) NC:Typ.25mV,250mV max.(at 10A)	Termination	QC, PCB ⁷⁾
Max. continuous current ^{1) 10)}	30A (Resistive)	Construction	Plastic sealed, Dust protected
Max. switching current ¹⁰⁾	30A (Resistive)	Unit weight	Approx. 22g
Max. switching voltage ²⁾	27VDC (Resistive)	Mechanical data ⁸⁾	cover retention (pull & push): 200N min. terminal retention (pull & push): 100N min. terminal resistance to bending (front & side): 10N min. ⁹⁾
Min. contact load	1A 6VDC		
Electrical endurance	See "CONTACT DATA"	1) For NO contacts, measured when applying 100% rated voltage on coil.	
Mechanical endurance	1 x 10 ⁷ ops (300ops/min)	2) See "Load limit curve" for details.	
Initial insulation resistance	100MΩ (at 500VDC)	3) 1min, leakage current less than 1mA.	
Dielectric strength ³⁾	500VAC	4) The value is measured when voltage drops suddenly from nominal voltage to 0 VDC and coil is not paralleled with suppression circuit.	
Operate time ¹⁰⁾	Typ.: 5ms (at nomi. vol.) Max.: 10ms (at nomi. vol.)	5) When energized, opening time of NO contacts shall not exceed 100μs, when non-energized, opening time of NC contacts shall not exceed 100μs, meantime, NO contacts shall not be closed.	
Release time ^{4) 10)}	Typ.: 2ms Max.: 10ms	6) FMVSS: Federal Motor Vehicle Safety Standard.	
Ambient temperature	-40°C to 125°C	7) Since it is an environmental friendly product, please select lead-free solder when welding. The recommended soldering temperature and time is (250±3)°C, (5±0.3)s.	
Vibration resistance ^{5) 10)}	10Hz to 60Hz 0.35mm DA 60Hz to 500Hz 49m/s ²	8) Only valid for QC version.	
Shock resistance ^{5) 10)}	196m/s ²	9) Test point is at 2mm away from terminal end, and after removing testing force, the terminal transfiguration shall not exceed 0.5mm.	
		10) Only for the 12VDC coil voltage type.	

CONTACT DATA ⁵⁾

Load voltage	Load type		Load current A			On/Off ratio		Electrical endurance OPS	Contact material	Load wiring diagram ³⁾	Ambient temp.
			1C		1A	On s	Off s				
			NO	NC	NO						
13.5VDC	Resistive	Make	20	10	30	2	2	1×10 ⁵	AgSnO ₂	See diagram 1 or diagram 4	See Ambient temp. curve
		Break	20	10	30	2	2				
	Inductive	Make ¹⁾	40	20	40	2	2	1×10 ⁵	AgSnO ₂	See diagram 2 or diagram 5	
		Break	20	10	20	2	2				
	Lamp ⁴⁾	Make	100 ²⁾	---	100 ²⁾	2	2	1×10 ⁵	AgSnO ₂	See diagram 3	
		Break	20	---	20	2	2				
27VDC	Resistive	Make	20	10	20	2	2	1×10 ⁵	AgSnO ₂	See diagram 1 or diagram 4	
		Break	20	10	20	2	2				
	Inductive	Make ¹⁾	38	28	38	2	2	1×10 ⁵	AgSnO ₂	See diagram 2 or diagram 5	
		Break	15	6	15	2	2				
	Lamp ⁴⁾	Make	70 ²⁾	---	70 ²⁾	2	2	1×10 ⁵	AgSnO ₂	See diagram 3	
		Break	7	---	7	2	2				



HONGFA RELAY

ISO9001, ISO/TS16949, ISO14001, OHSAS18001, IECQ QC 080000 CERTIFIED

2012 Rev. 1.01

- 1) Corresponds to the peak inrush current on initial actuation.
- 2) Corresponds to the peak inrush current on initial actuation (cold filament).
- 3) The load wiring diagrams are listed below:

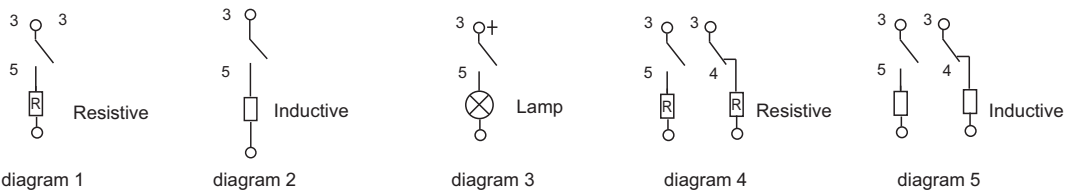

- 4) The load in the table excludes flasher. When applied in flasher, please connect by the polarity request according diagram 3, a special silver alloy contact material should be used and the customer special code should be (170) as a suffix.
- 5) Loads mentioned in this chart is for relays with no parallel diode or Zener Diode. For those with parallel diode, Zener Diode or other components, please contact Hongfa for more technical supports.
Please also contact Hongfa if the actual application load is different from what mentioned above.

COIL DATA

at 23°C

	Nominal voltage VDC	Pick-up voltage VDC max.	Drop-out voltage VDC min.	Coil resistance $x(1\pm 10\%)\Omega$	Parallel resistance $x(1\pm 5\%)\Omega$	Equivalent resistance $x(1\pm 10\%)\Omega$	Power consumption W	Max. allowable overdrive voltage ¹⁾ VDC	
								at 23°C	at 85°C
Standard	12	7.2	1.2	90	---	---	1.6	20	15
	12	7.2	1.2	90	680	79.5	1.8	20	15
	24	14.4	2.4	360	---	---	1.6	40	30
	24	14.4	2.4	360	2700	317.6	1.8	40	30
Sensitive	12	7.2	1.2	124	---	---	1.2	25	19
	12	7.2	1.2	124	680	104.9	1.4	20	15
	24	14.4	2.4	441	---	---	1.3	47	35
	24	14.4	2.4	441	1800	354.2	1.6	33	25

1) Max. allowable overdrive voltage is stated with no load applied and minimum coil resistance.

ORDERING INFORMATION

		HFV6 / 012 Z S L -T R (XXX)	
Type	HFV6: QC	HFV6-K: Grip & QC	
	HFV6-P: PCB		
Coil voltage	012: 12VDC	024: 24VDC	
Contact arrangement	H: 1 Form A	Z: 1 Form C	
Construction ¹⁾	S: Plastic sealed ²⁾	Nil: Dust protected	
Coil power	L: Sensitive	Nil: Standard	
Contact material	T: AgSnO ₂		
Parallel coil ³⁾ components	R: Parallel transient suppression resistors D: Parallel transient suppression diode, with anode connected to terminal#2 D1: Parallel transient suppression diode, with anode connected to terminal#1 Nil: Without parallel components		
Customer special code	e.g. (170) stands for flasher load		

1) Dust protected version is recommended.

2) If water cleaning is required after the relay is assembled on PCB, please contact us for suggestion about suitable parts.

3) If parallel diode, Zener Diode or other components are required, please contact Hongfa for more technical supports.

OUTLINE DIMENSIONS AND WIRING DIAGRAM

Unit: mm

Outline Dimensions

HFV6/□□□Z□□-□□(XXX)

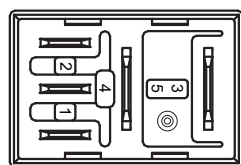
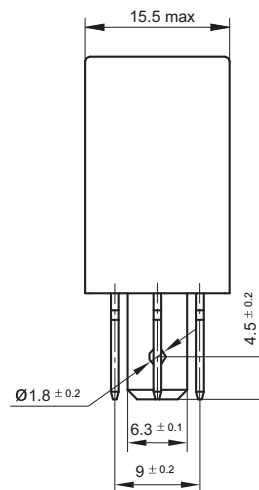
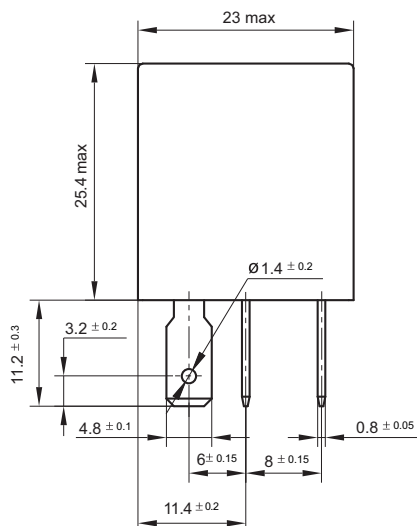

(Bottom view)

HFV6-P/□□□Z□□-□□(XXX)

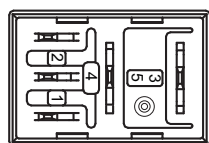
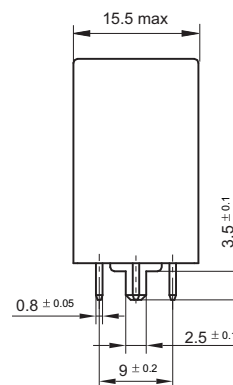
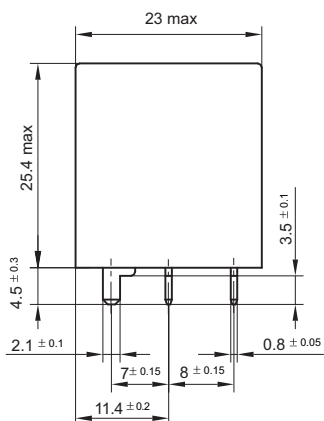

(Bottom view)

OUTLINE DIMENSIONS AND WIRING DIAGRAM

Unit: mm

HFV6-K/□□□Z□□-□□(XXX)

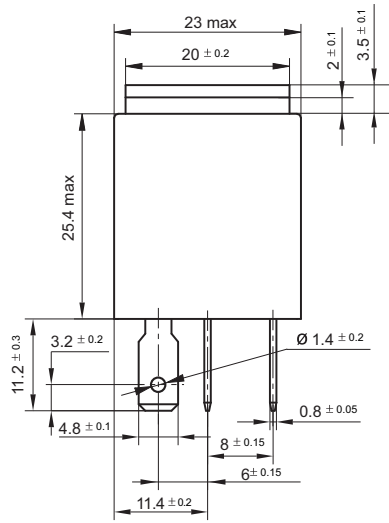

Outline Dimensions

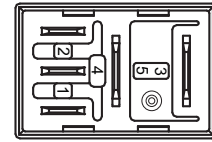
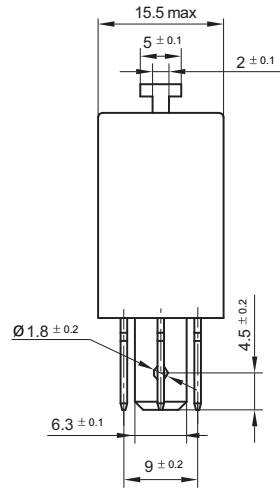

(Bottom view)

Remark: Terminal vertical deviation tolerance is 0.3mm.

Wiring Diagram

HFV6/□□□H□□-□(XXX)

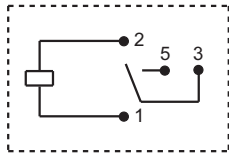

HFV6/□□□Z□□-□(XXX)

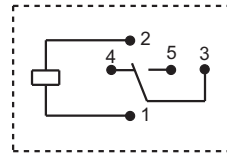

HFV6/□□□H□□-□R(XXX)

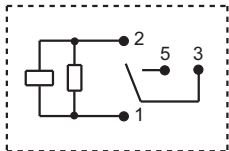

HFV6/□□□Z□□-□R(XXX)

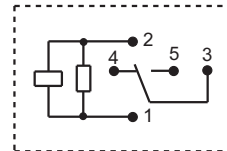

HFV6/□□□H□□-□D(XXX)

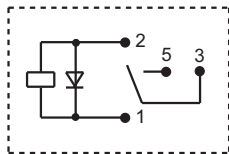

HFV6/□□□Z□□-□D(XXX)

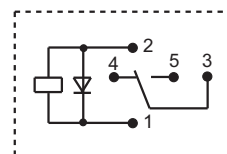

HFV6/□□□H□□-□D1(XXX)

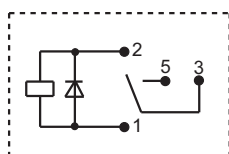

HFV6/□□□Z□□-□D1(XXX)

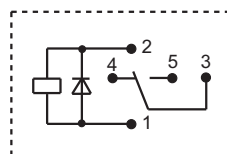

CHARACTERISTIC CURVES

1. Coil operating voltage range

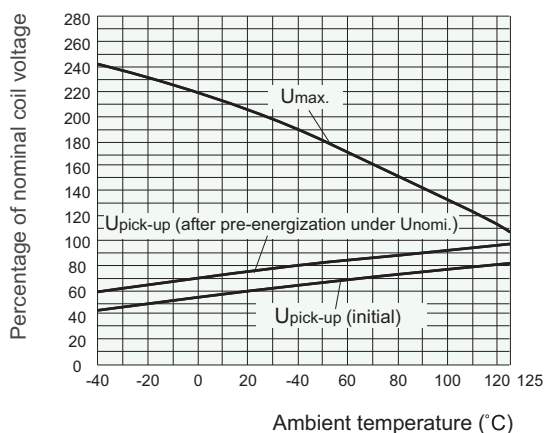

- 1) The operating voltage is connected with coil pre-energized time and voltage. After pre-energized, the operating voltage will increase.
- 2) The maximum allowable coil temperature is 180°C. For the coil temperature rise which is measured by resistance is average value, we recommend the coil temperature should be below 170°C under the different application ambient, different coil voltage and different load etc.
- 3) If the actual operating coil voltage is out of the specified range, please contact Hongfa for further details.

2. Load limit curve

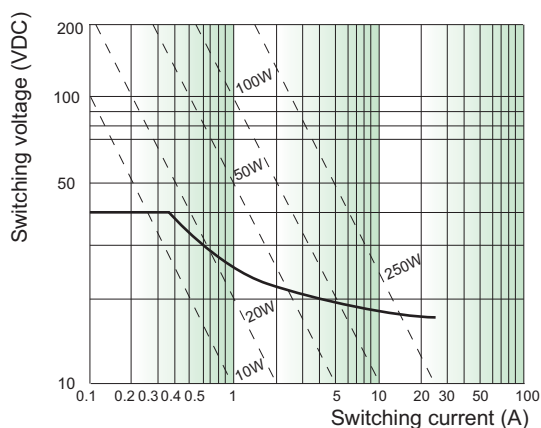

- 1) The load and electrical endurance tests are made according to "CONTACT DATA" parameters' table. If actual load voltage, current, or operate frequency is different from "CONTACT DATA" table, please arrange corresponding tests for confirmation.

3. Ambient temperature curve of the electrical endurance test

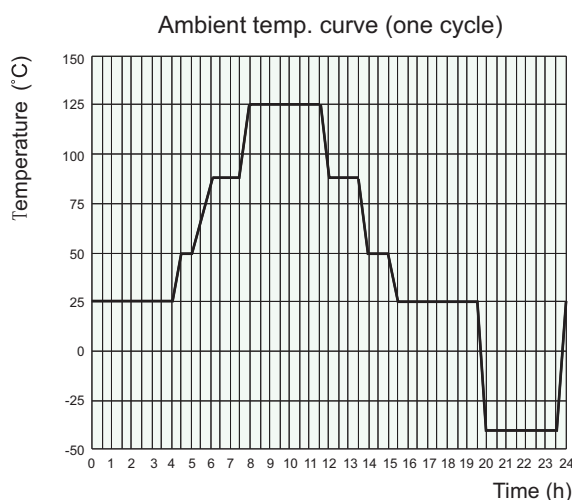

- 1) The minimum temperature is -40°C.
- 2) The maximum temperature is 125°C.

Disclaimer

This datasheet is for the customers' reference. All the specifications are subject to change without notice.

We could not evaluate all the performance and all the parameters for every possible application. Thus the user should be in a right position to choose the suitable product for their own application. If there is any query, please contact Hongfa for the technical service. However, it is the user's responsibility to determine which product should be used only.

© Xiamen Hongfa Electroacoustic Co., Ltd. All rights of Hongfa are reserved.