

HF118F 2 pole**MINIATURE HIGH POWER RELAY**

File No.: E134517



File No.: 40010480



File No.: CQC09002035071

**Features**

- 5A switching capability
- 5kV dielectric strength (between coil and contacts)
- Low height: 12.5 mm
- Creepage distance >8mm
- Meeting VDE 0700, 0631 reinforce insulation
- Product in accordance to IEC 60335-1 available
- 2 pole configurations available
- UL insulation system: Class F
- Sockets available
- Plastic sealed and flux proofed types available
- Environmental friendly product (RoHS compliant)
- Outline Dimensions: (28.5 x 10.1 x 12.5) mm

CONTACT DATA

Contact arrangement	2A, 2B, 2C
Contact material	See ordering info.
Contact resistance	100mΩ max.(at 1A 6VDC)
Contact rating (Res. load)	5A 250VAC/30VDC
Max. switching voltage	440VAC / 125VDC
Max. switching current	5A
Max. switching power	1250VA / 150W
Mechanical endurance	1 x 10 ⁷ OPS
Electrical endurance	1 x 10 ⁵ OPS (See approval reports for more details)

CHARACTERISTICS

Insulation resistance	1000MΩ (at 500VDC)	
Dielectric strength	Between coil & contacts	5000VAC 1min
	Between open contacts	1000VAC 1min
	Between contact sets	2500VAC 1min
Surge voltage (between coil & contacts)	10kV (1.2 / 50μs)	
Operate time (at nomi. vot.)	10ms max.	
Release time (at nomi. vot.)	5ms max.	
Temperature rise (at nomi. Volt.)	55K max.	
Shock resistance *	Functional	NC: 49m/s ² NO: 98m/s ²
	Destructive	980m/s ²
Vibration resistance*	NC (no coil voltage)	10Hz to 55Hz 0.5mm DA
	NO	10Hz to 55Hz 1.65mm DA
Ambient temperature	-40°C to 85°C	
Humidity	5% to 85% RH	
Termination	PCB	
Unit weight	Approx. 8g	
Construction	Plastic sealed, Flux proofed	

Notes: 1) The data shown above are initial values.
2) * Index is not in relay length direction.

COIL

Coil power	Approx. 360mW
------------	---------------

COIL DATA

at 23°C

Nominal Voltage VDC	Pick-up Voltage VDC max.	Drop-out Voltage VDC min.	Max. Allowable Voltage VDC *	Coil Resistance Ω
5	3.50	0.5	7.5	70 x (1±10%)
6	4.20	0.6	9.0	100 x (1±10%)
9	6.30	0.9	13.5	225 x (1±10%)
12	8.40	1.2	18.0	400 x (1±10%)
18	12.60	1.8	27.0	900 x (1±10%)
24	16.80	2.4	36.0	1600 x (1±10%)
48	33.60	4.8	72.0	6400 x (1±15%)
60	42.00	6.0	90.0	10000 x (1±15%)

Notes: * The max. allowable voltage in the COIL DATA is coil overdrive voltage, it is the instantaneous max. voltage which the relay coil could endure in a very short time.



HONGFA RELAY

ISO9001、ISO/TS16949、ISO14001、OHSAS18001 CERTIFIED

2013 Rev. 1.00

SAFETY APPROVAL RATINGS

UL/CUR (AgNi, AgSnO ₂)	version 4	5A 250VAC
VDE (AgNi, AgNi+Au)	2Z (-;S) 4. (-;G)	3A 250VAC at 85°C 3A 30VDC at 85°C
VDE (AgSnO ₂ , AgSnO ₂ +Au)	2Z (-;S) 4T. (-;G)	3A 250VAC at 85°C 3A 30VDC at 85°C

Notes: Only some typical ratings are listed above. If more details are required, please contact us.

ORDERING INFORMATION

Type	HF118F / 012 -2H S 4 G (XXX)
Coil voltage	5, 6, 9, 12, 18, 24, 48, 60VDC
Contact arrangement	2H: 2 Form A 2D: 2 Form B 2Z: 2 Form C
Construction ¹⁾	S: Plastic sealed Nil: Flux proofed
Version	4: 3.2mm 2 pole
Contact material ²⁾	T: AgSnO ₂ G: AgNi+Au plated TG: AgSnO ₂ +Au plated Nil: AgNi
Customer special code	e.g. (335) stands for product in accordance to IEC 60335-1 (GWT)

- Notes:** 1) We recommend flux proofed types for a clean environment (free from contaminations like H₂S, SO₂, NO₂, dust, etc.). We suggest to choose plastic sealed types and validate it in real application for an unclean environment (with contaminations like H₂S, SO₂, NO₂, dust, etc.). If water cleaning is required after the relay is assembled on PCB, please contact us for suggestion about suitable parts.
2) For gold plated type, the min. switching current and min. switching voltage is 10mA 5VDC.

OUTLINE DIMENSIONS, WIRING DIAGRAM AND PC BOARD LAYOUT

Unit: mm

Outline Dimensions

Wiring Diagram
(Bottom view)

PCB Layout
(Bottom view)

2 Form A

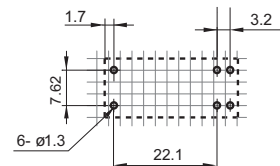
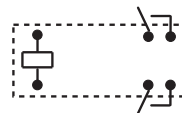
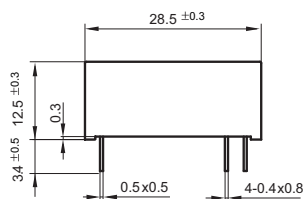

OUTLINE DIMENSIONS, WIRING DIAGRAM AND PC BOARD LAYOUT

Unit: mm

Outline Dimensions

Wiring Diagram (Bottom view)

PCB Layout (Bottom view)

2 Form B

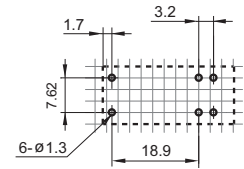
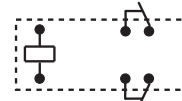
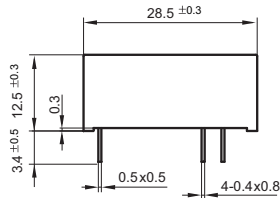

2 Form C

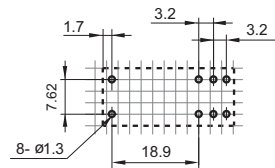
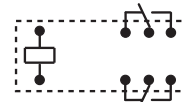
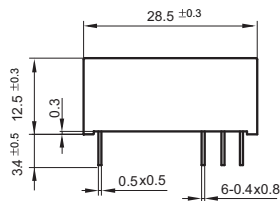

- Remark: 1) In case of no tolerance shown in outline dimension: outline dimension ≤ 1 mm, tolerance should be ± 0.2 mm; outline dimension > 1 mm and ≤ 5 mm, tolerance should be ± 0.3 mm; outline dimension > 5 mm, tolerance should be ± 0.4 mm.
 2) The tolerance without indicating for PCB layout is always ± 0.1 mm.
 3) The width of the gridding is 2.54mm.

CHARACTERISTIC CURVES

MAXIMUM SWITCHING POWER

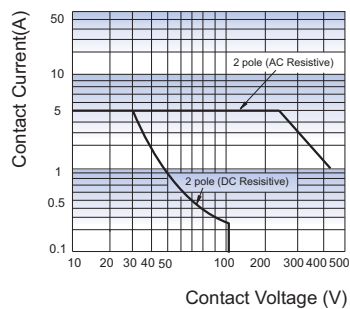

ENDURANCE CURVE

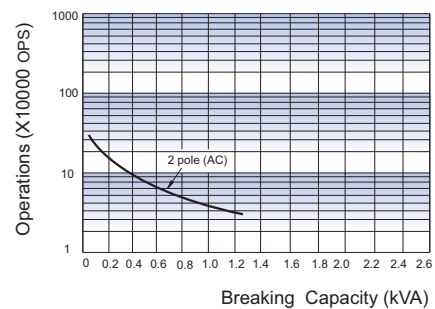

Disclaimer

This datasheet is for the customers' reference. All the specifications are subject to change without notice.

We could not evaluate all the performance and all the parameters for every possible application. Thus the user should be in a right position to choose the suitable product for their own application. If there is any query, please contact Hongfa for the technical service. However, it is the user's responsibility to determine which product should be used only.

© Xiamen Hongfa Electroacoustic Co., Ltd. All rights of Hongfa are reserved.